

2.53 BA > 4223000 SERIE B (2007) > GRASFANGSACK

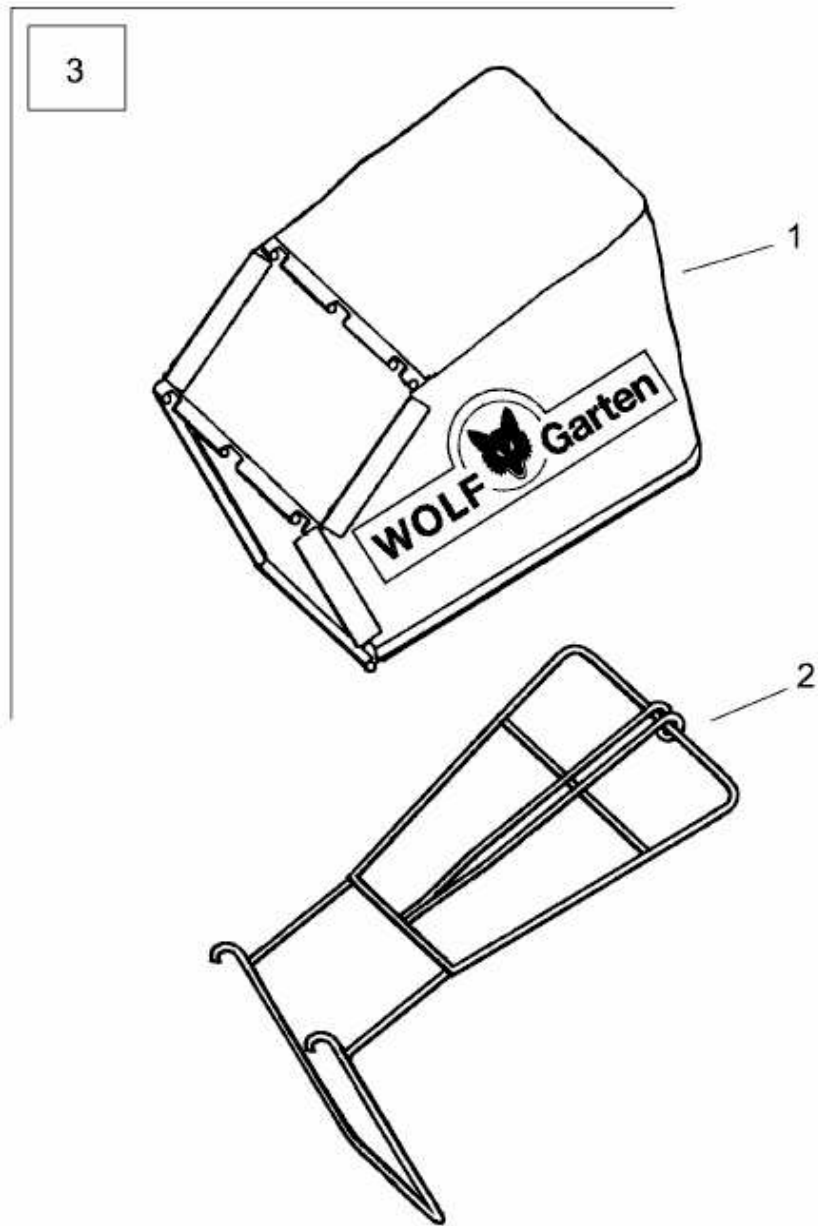

4218065