

2.53 BA > 4223000 SERIE B (2007) > RÄDER, SCHNITTHÖHENVERSTELLUNG

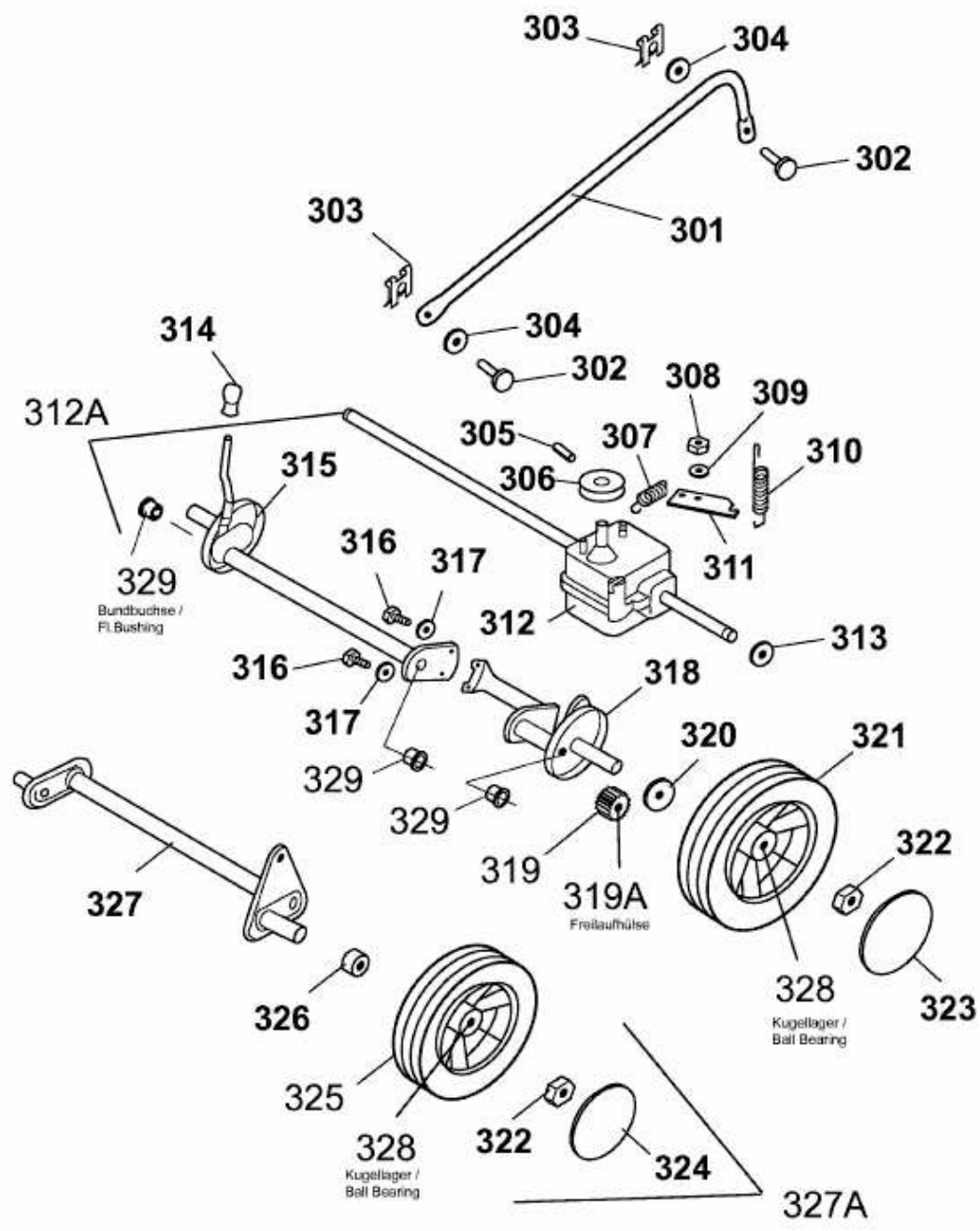

4223000B-2