

2.48 Q 5 > 4218009 SERIE A (2008) > MESSER, MESSERAUFNAHME, MOTOR

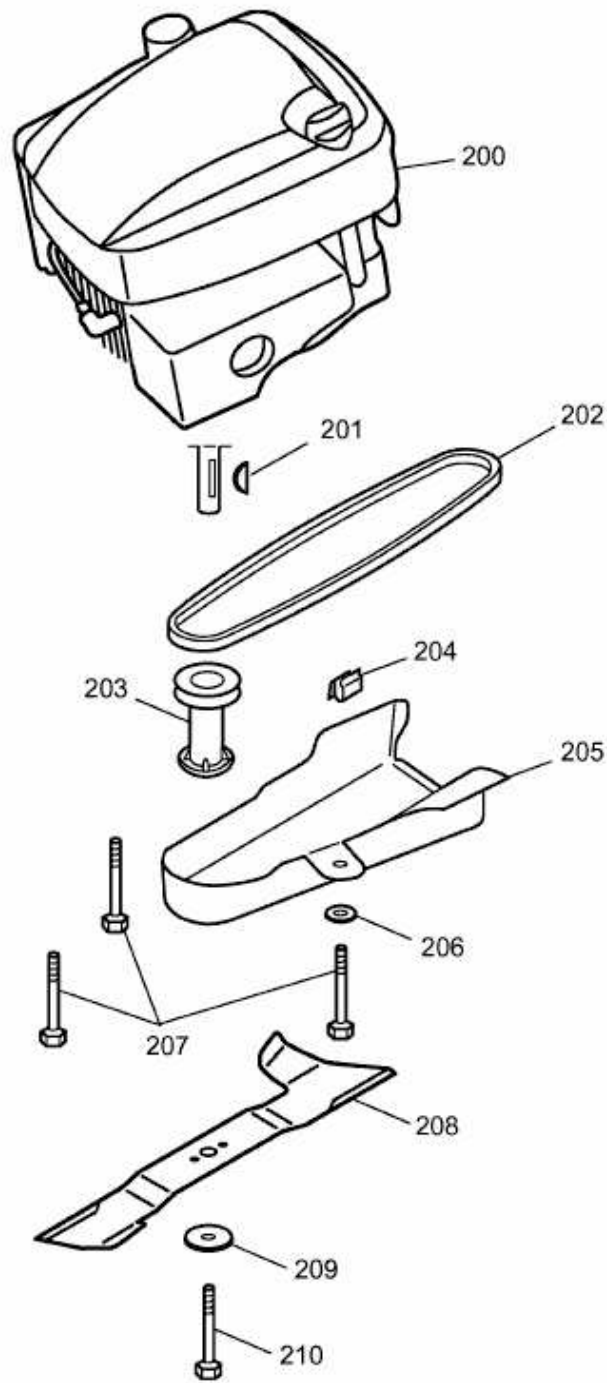

4218009A-3