

GCS 46/45 > 41BY4340678 (2013) > HANDGRIFF, MOTORABDECKUNGEN

GCS 46/40 41BY4640678
GCS 46/45 41BY4340678

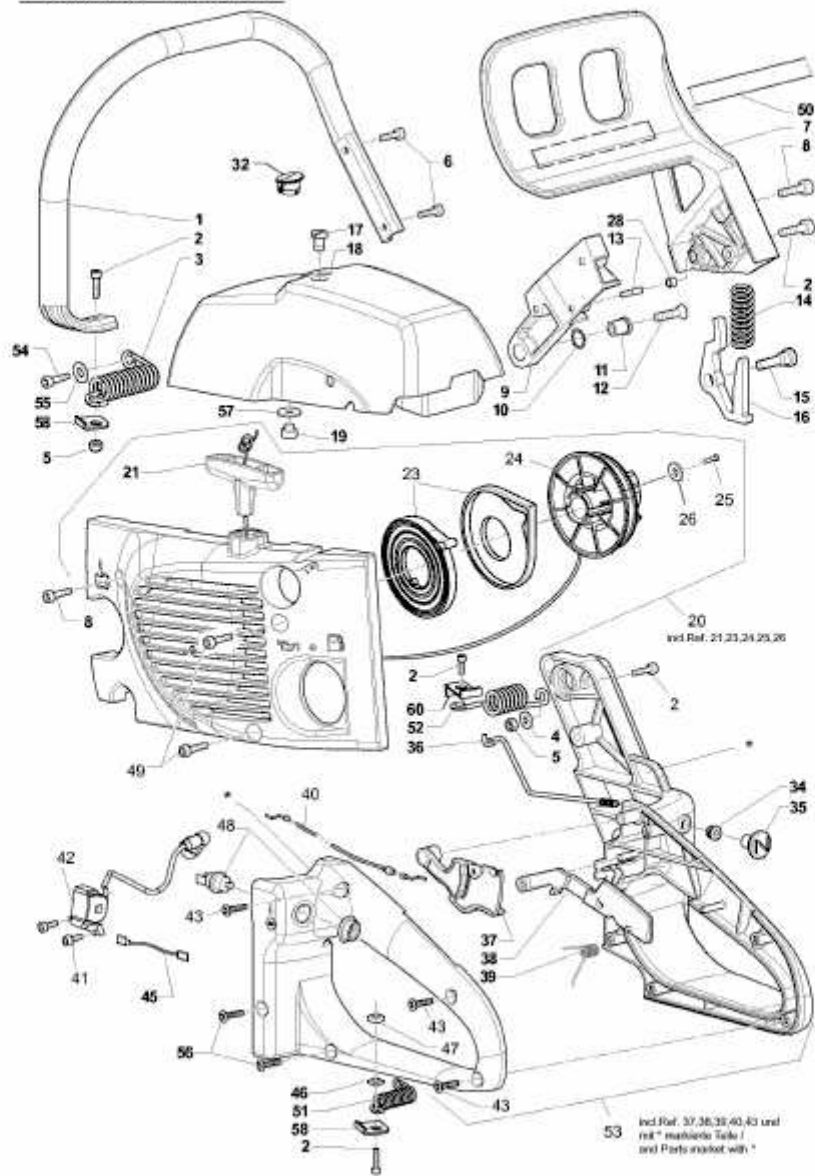

E3-07252A-01