

32

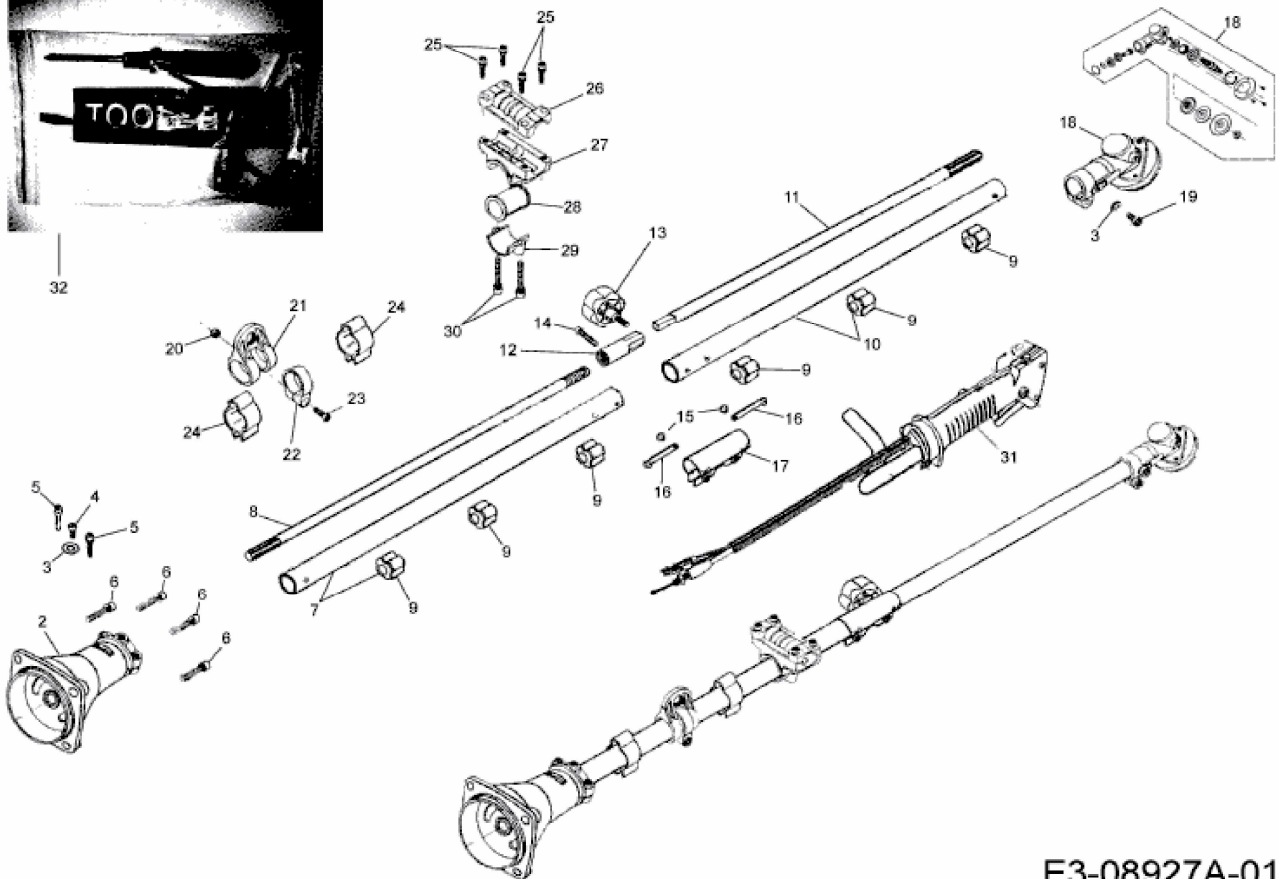

E3-08927A-01