

GCS 46/40 C > 41AY4640678 (2010) > HANDGRIFF, MOTORABDECKUNGEN

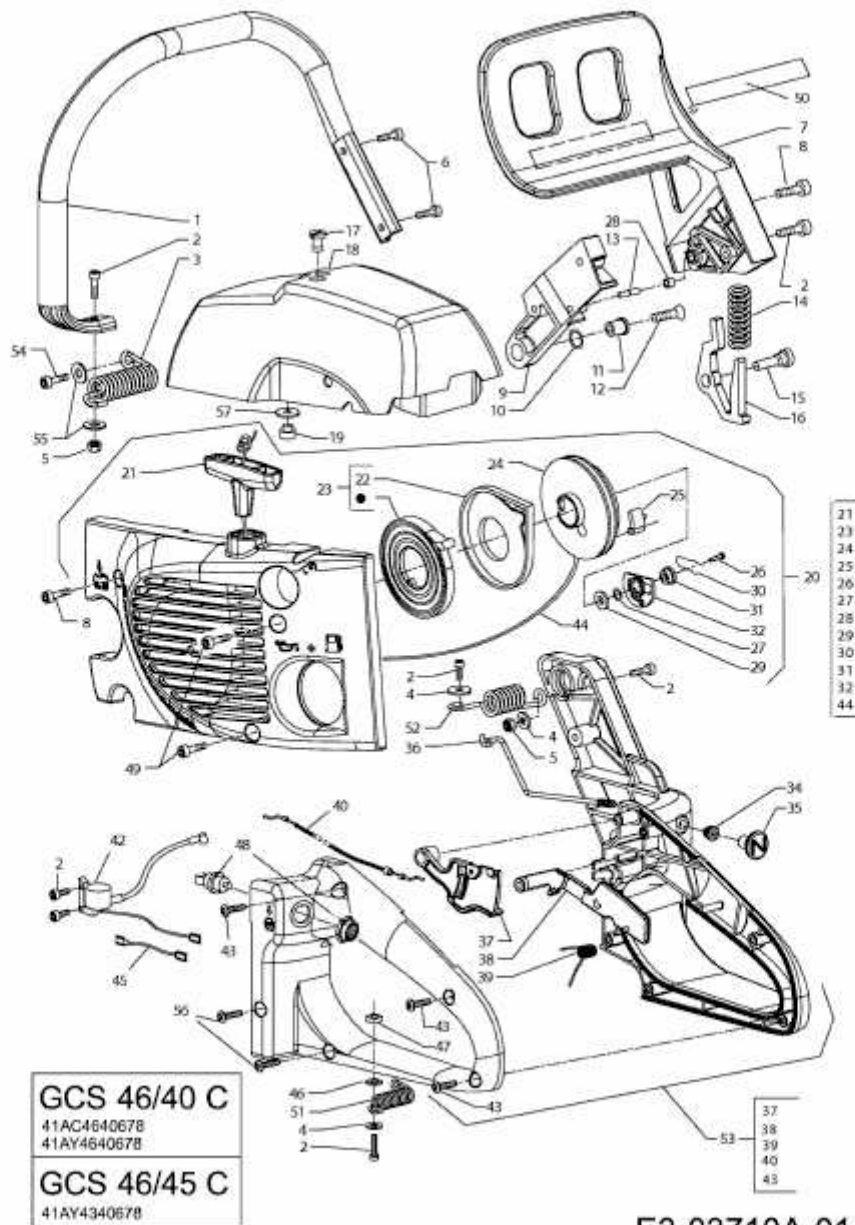

E3-03710A-01