

GCS 46/40 C > 41AY4640678 (2009) > AUSPUFF, LUFTFILTER, VERGASER

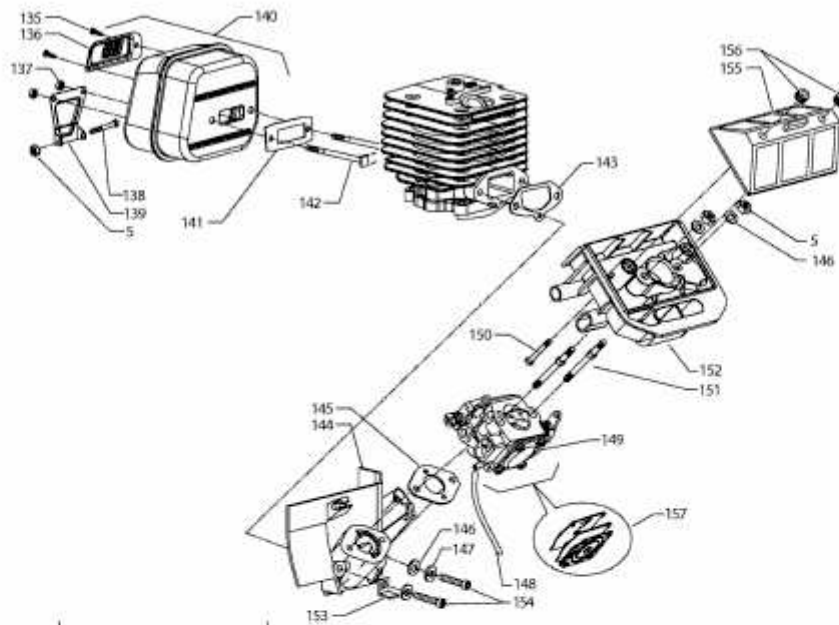

GCS 46/40 C 41AC4640678 41AY4640678
GCS 46/45 C 41AY4340678

E3-03712A-01