

GCS 46/45 C > 41AY4340678 (2010) > AUSPUFF, LUFTFILTER, VERGASER

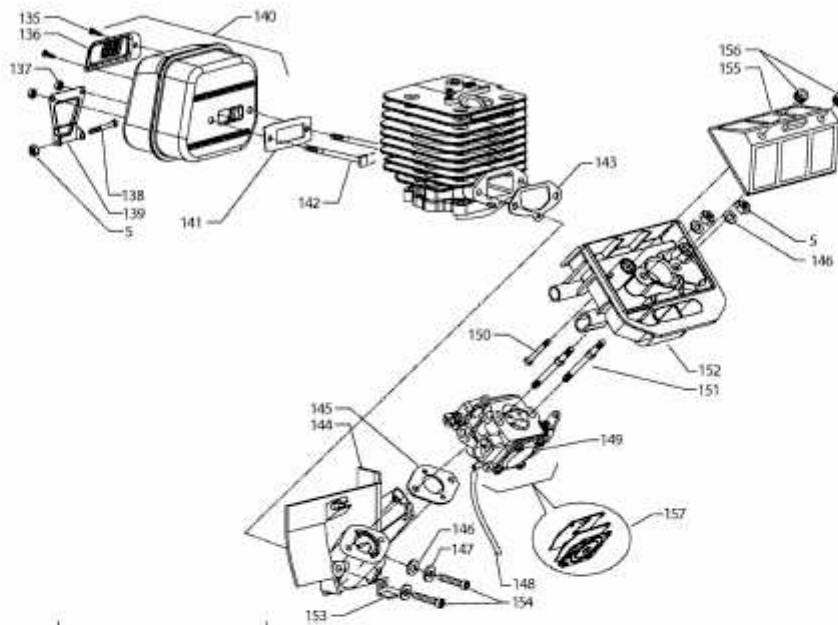

GCS 46/40 C
41AC4640678
41AY4640678

GCS 46/45 C
41AY4340678

E3-03712A-01