

CAMPUS 350 RT > 41AC0UU-650 (2015) > GRUNDGERÄT

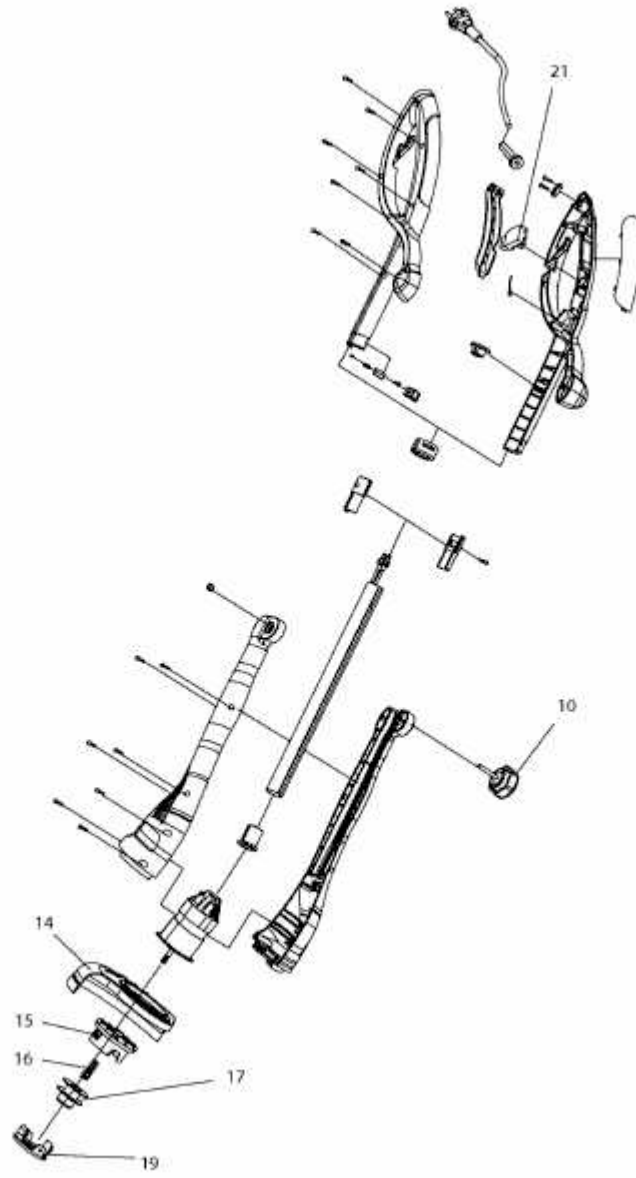

E3-07511A-01