

CAMPUS 350 RT > 41AC0UU-650 (2014) > GRUNDGERÄT

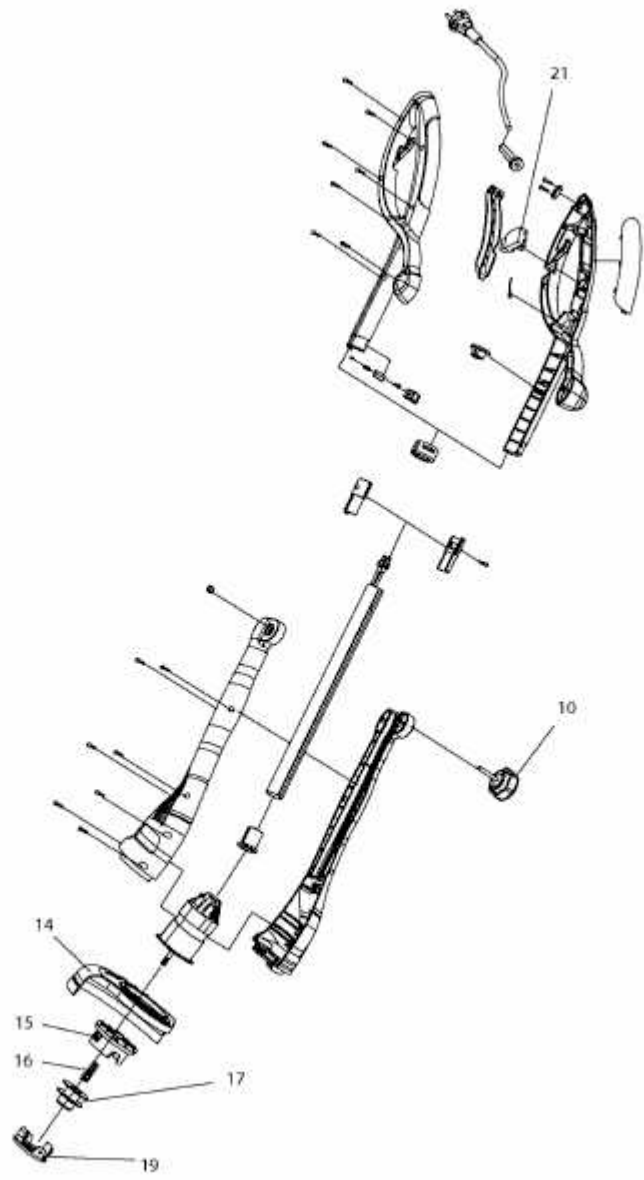

E3-07511A-01