

SEILWINDE > 39A-205-100 (2013) > GRUNDGERÄT

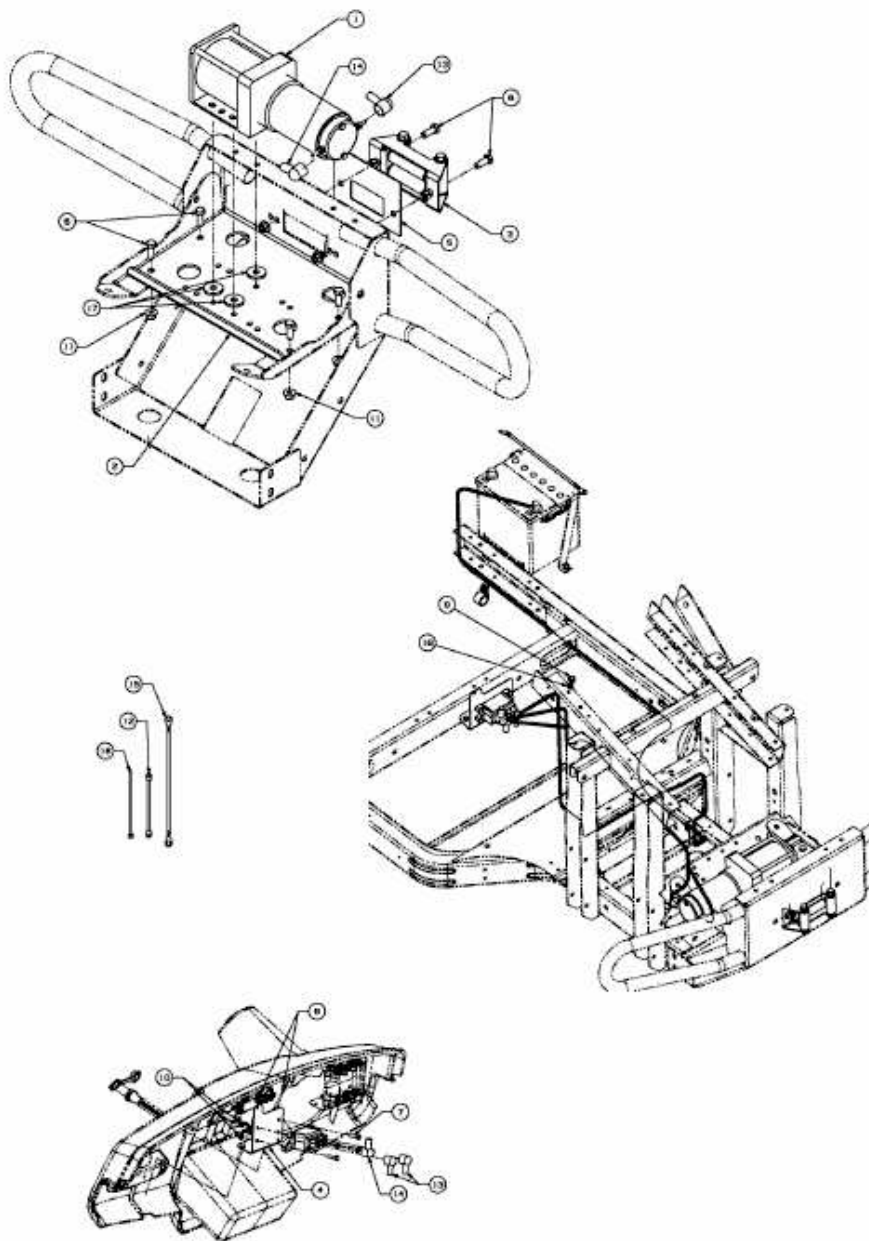

E3-07329A-01