

BIG COUNTRY > 37AS640D603 (2006) > GETRIEBEGEHÄUSE

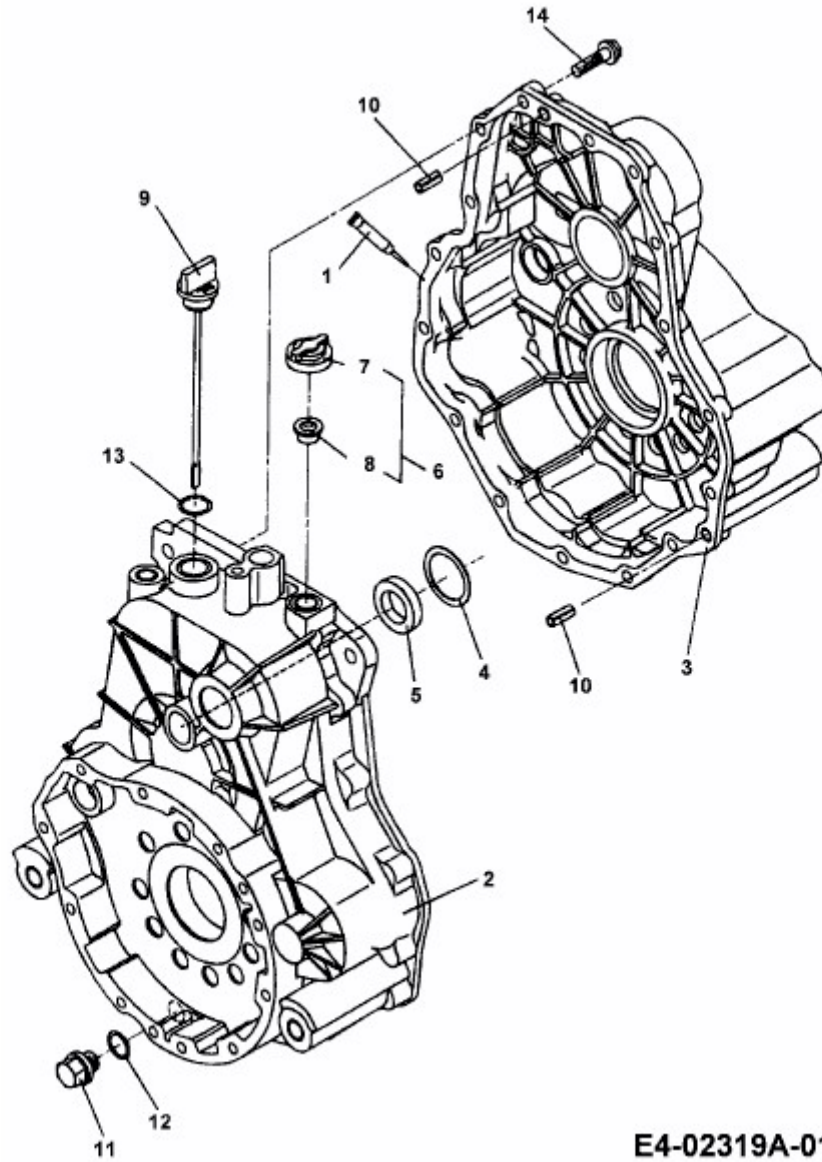

E4-02319A-01