

MF 20 MD > 37AK468D695R (2017) > BOWDENZÜGE, BREMSPEDAL, BREMSSCHLÄUCHE,
HANDBREMSHEBEL

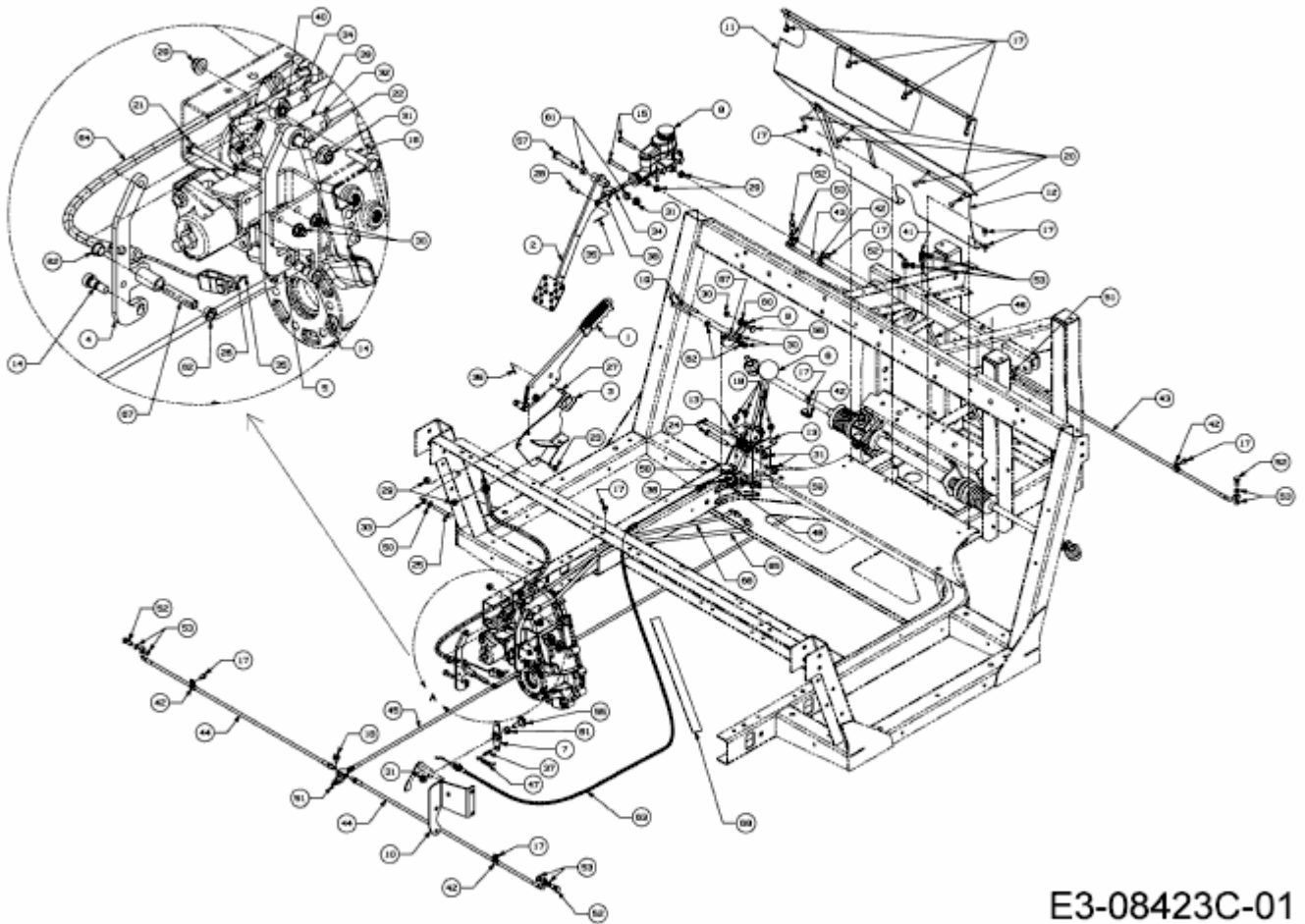

E3-08423C-01