

MF 20 MD > 37AK468D695R (2015) > BOWDENZÜGE, BREMSPEDAL, BREMSSCHLÄUCHE,
HANDBREMSHEBEL

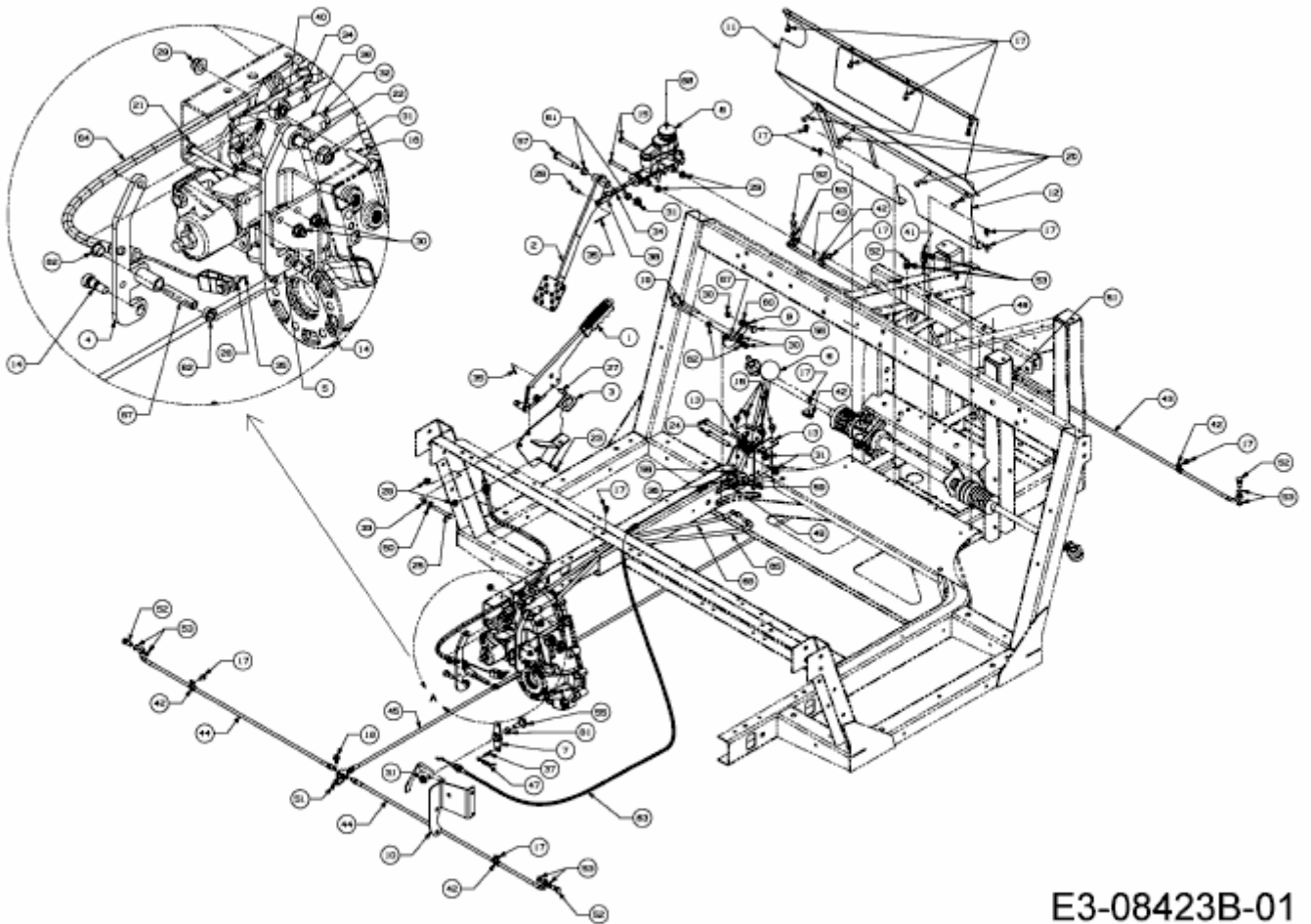

E3-08423B-01