

MF 20 MD > 37AK468D695 (2012) > BOWDENZÜGE, BREMSPEDAL, BREMSSCHLÄUCHE,
HANDBREMSHEBEL

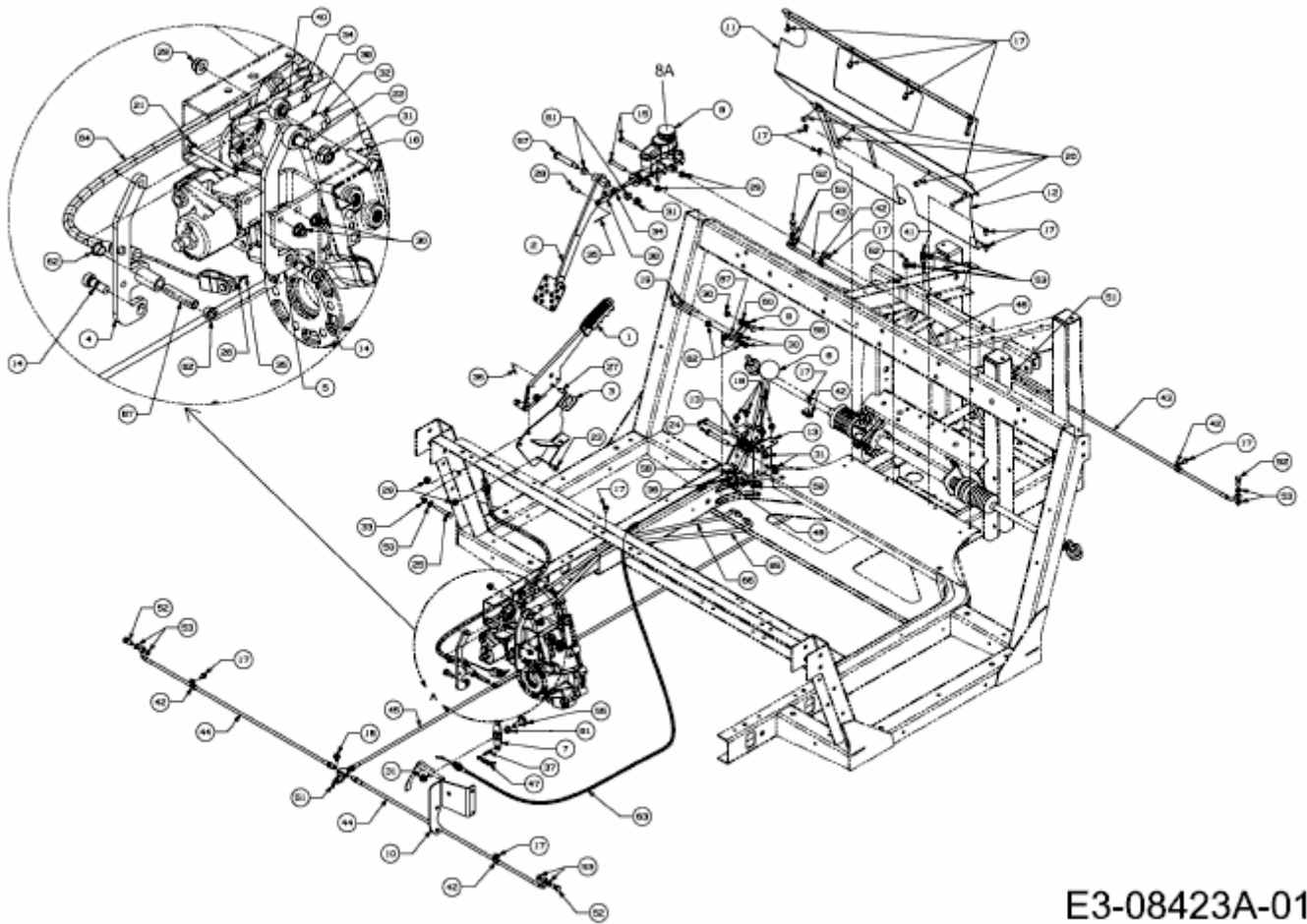

E3-08423A-01