

UV 32 EV > 3632683 SERIE J (2011) > ELEKTROMOTOR, HECKKLAPPE, KEILRIEMEN

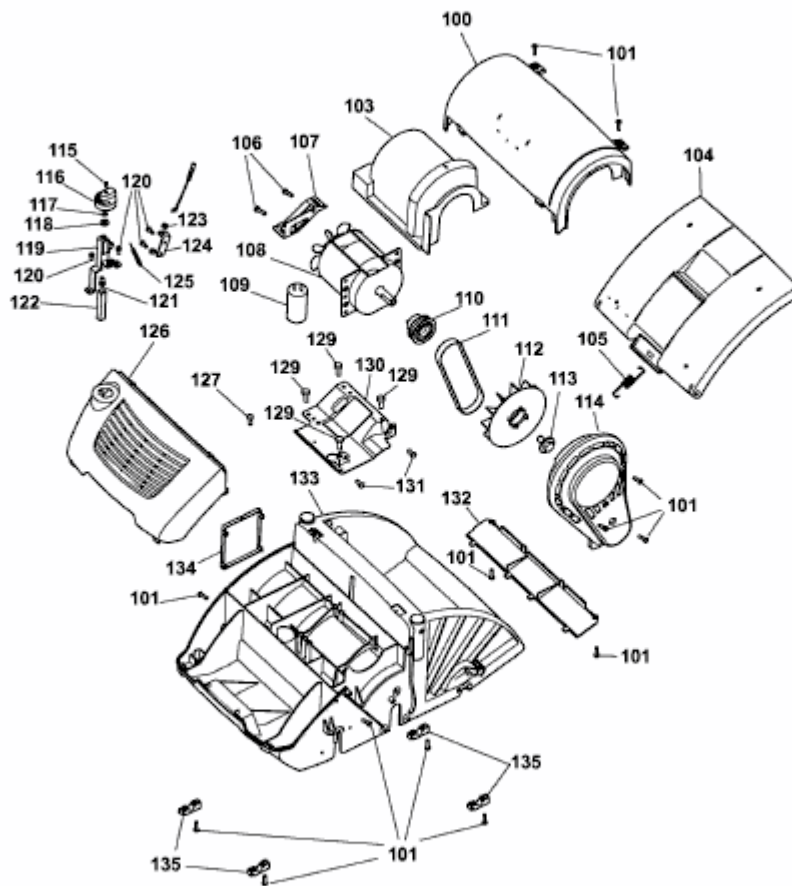

E3-06879A-01