

UV 32 EV > 3632683 SERIE H (2008) > ELEKTROMOTOR, KEILRIEMEN

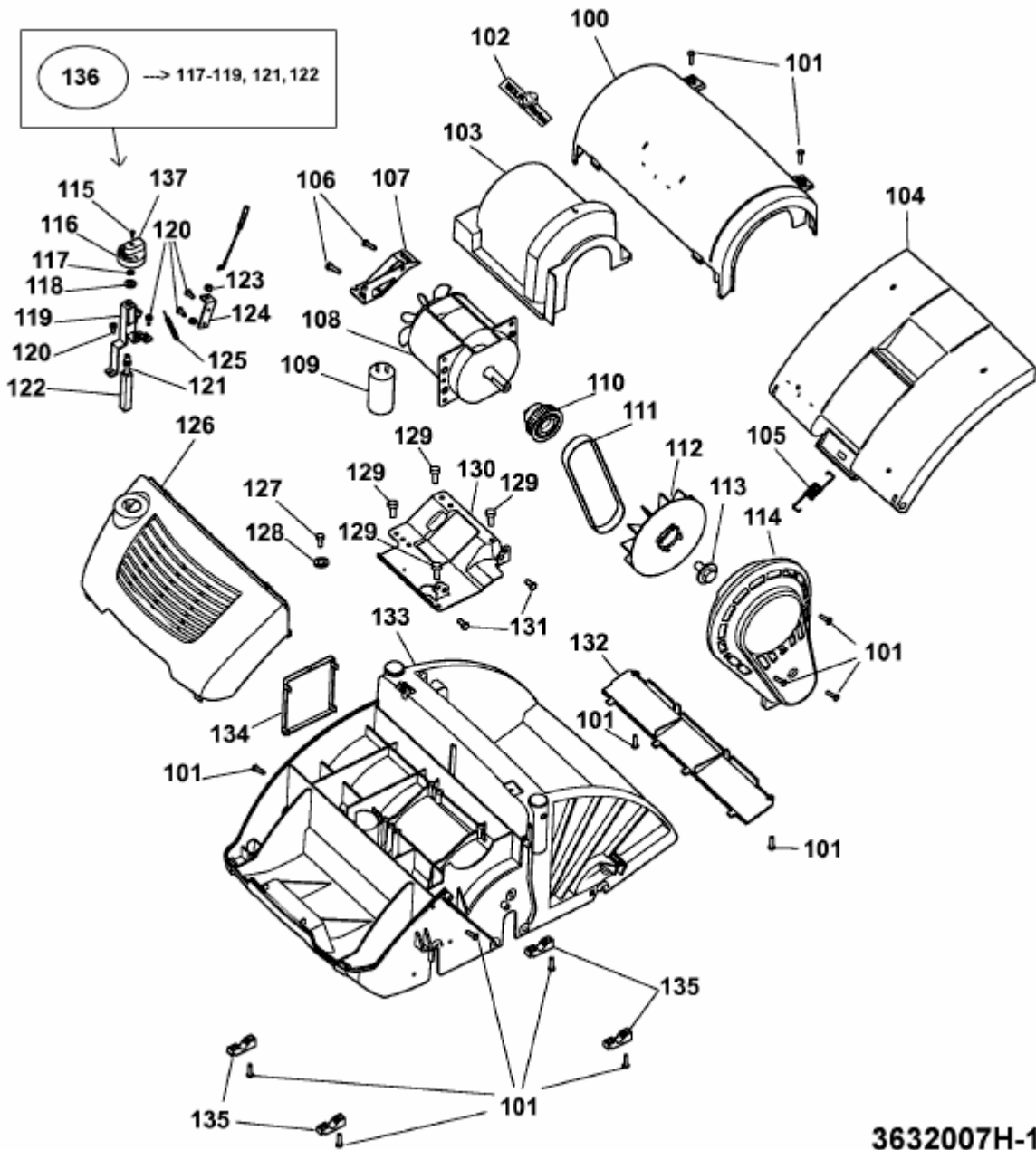

3632007H-1