

UV 32 EV > 3632680 (2014) > ELEKTROMOTOR, KEILRIEMEN

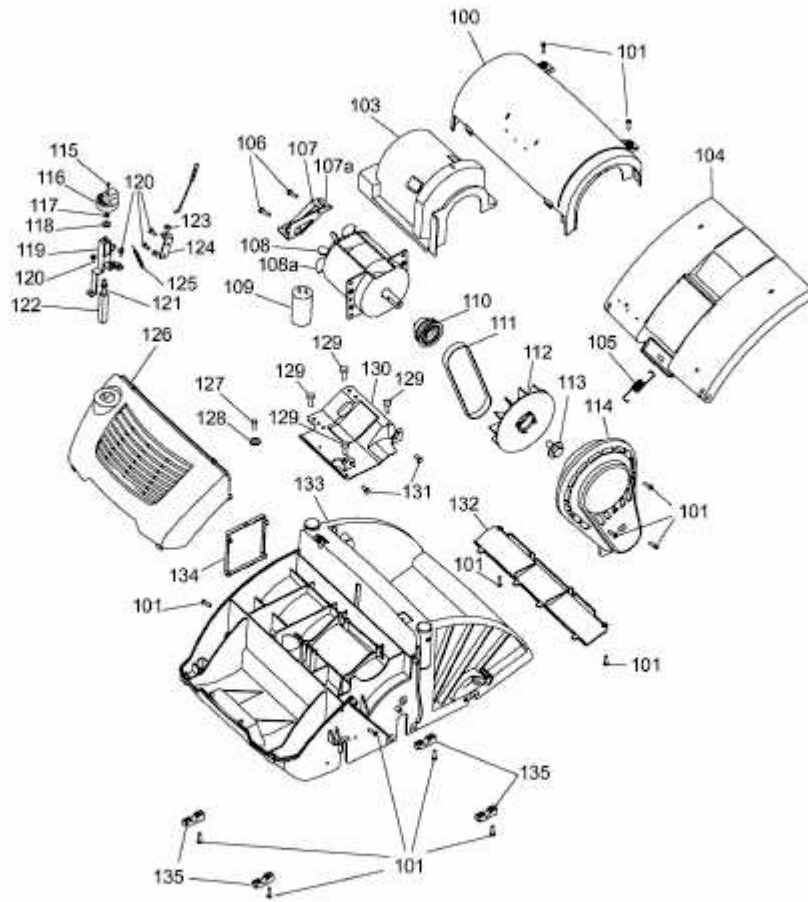

E3-08363A-01