

TT 380 DL > 3623000 (2012) > GRUNDGERÄT

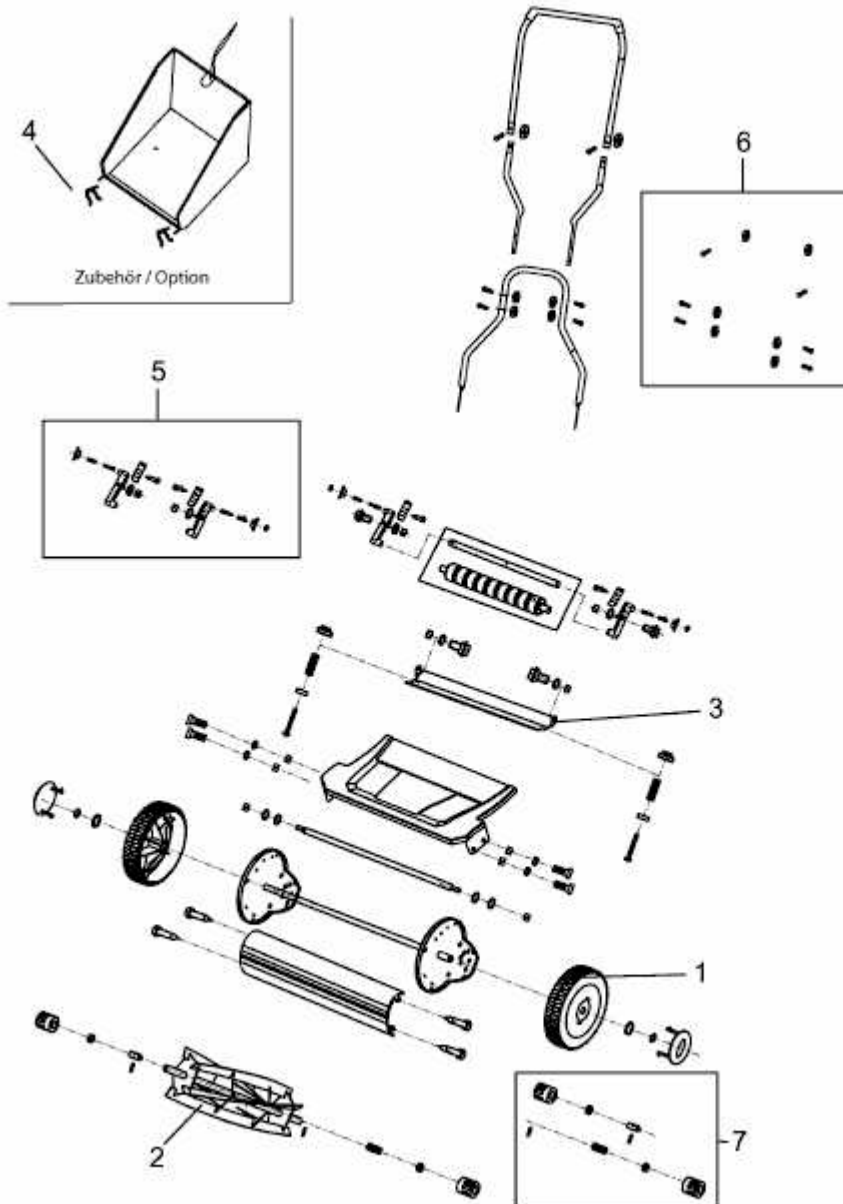

E3-06015A-01