

TT 350 S > 3622000 (2011) > GRUNDGERÄT

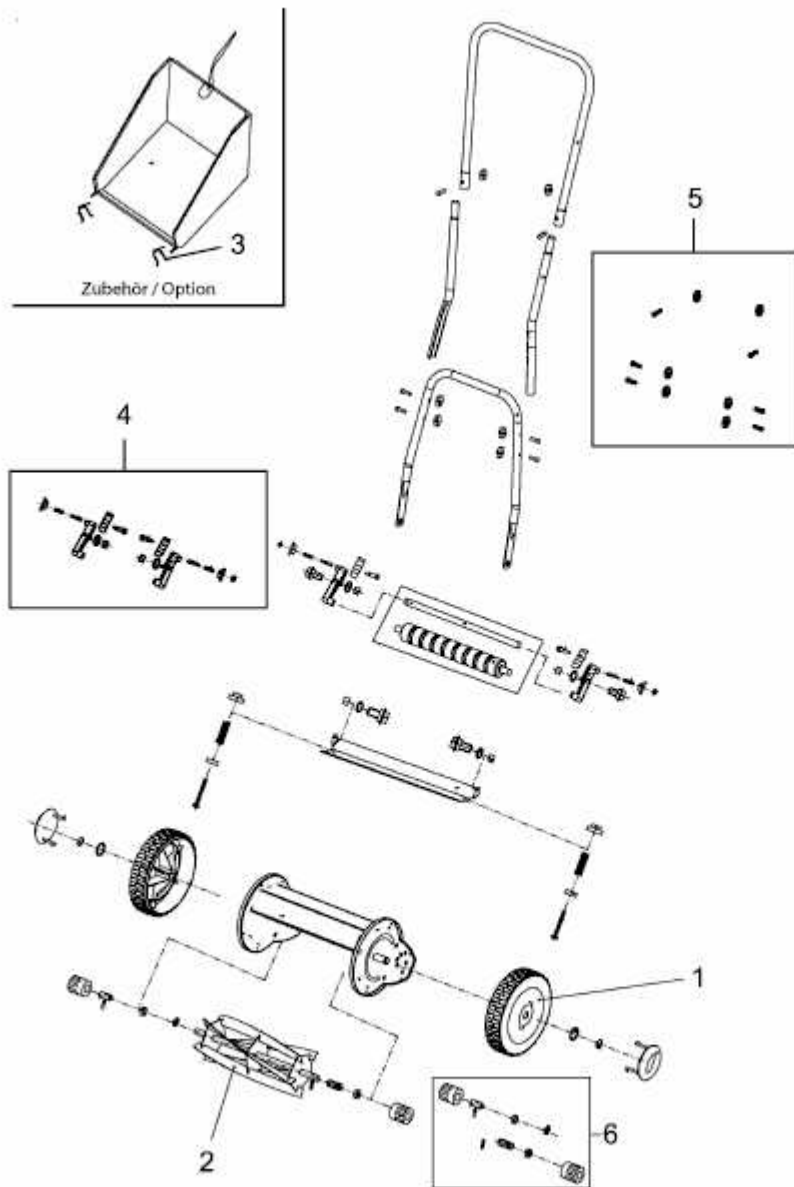

E3-06014A-01