

YM 8413 DE > 31AY9PKV643 (2009) > FAHRANTRIEB, FRÄSANTRIEB

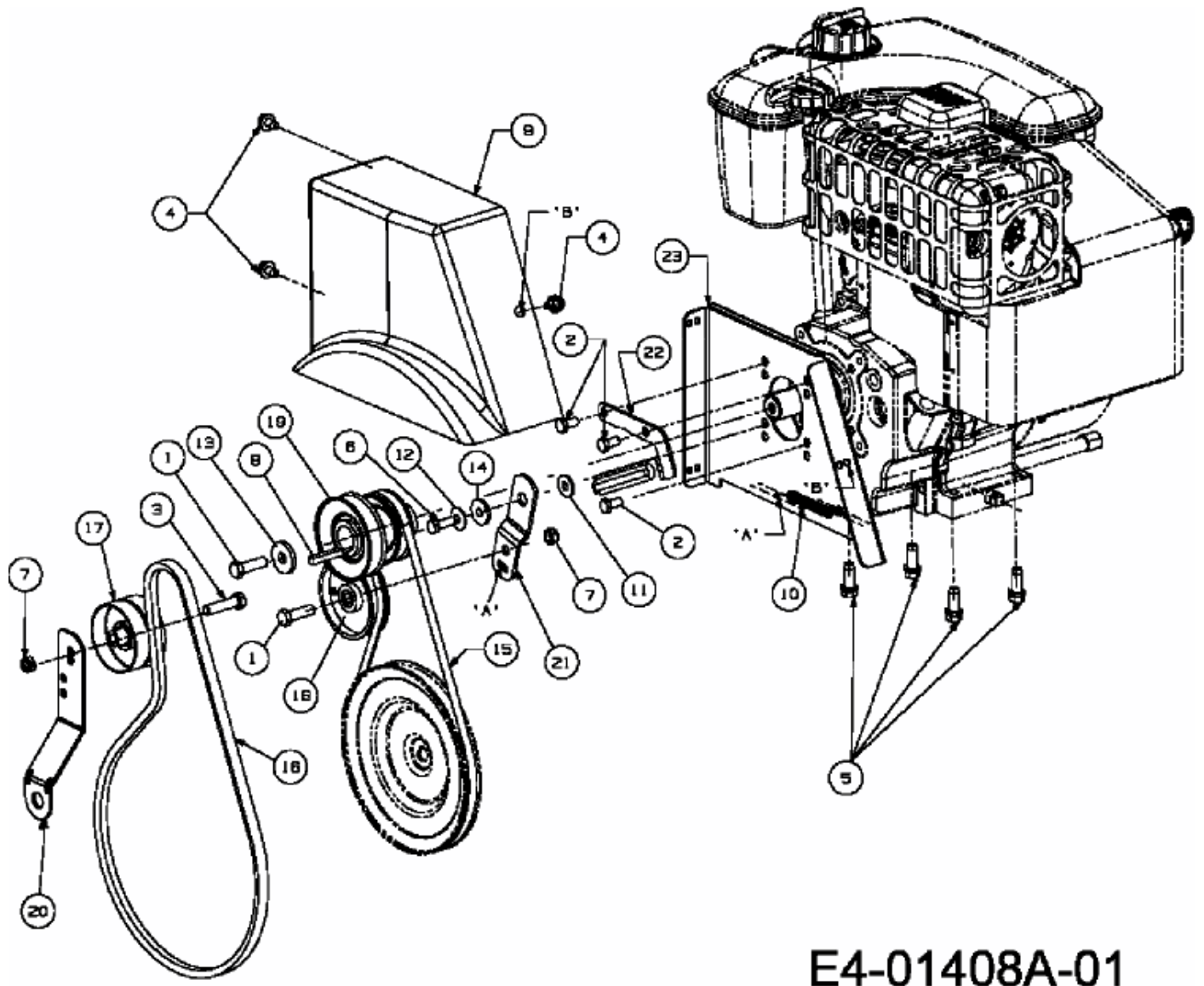

E4-01408A-01