

YM 8413 DE > 31AY9PKV643 (2009) > FRÄSANTRIEB, SCHAUFELRAD

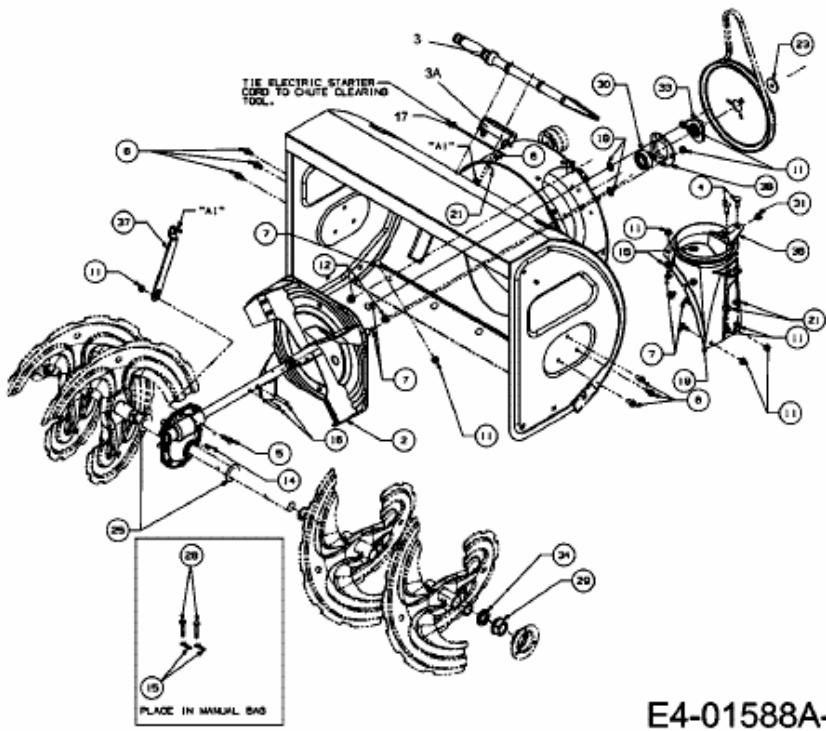
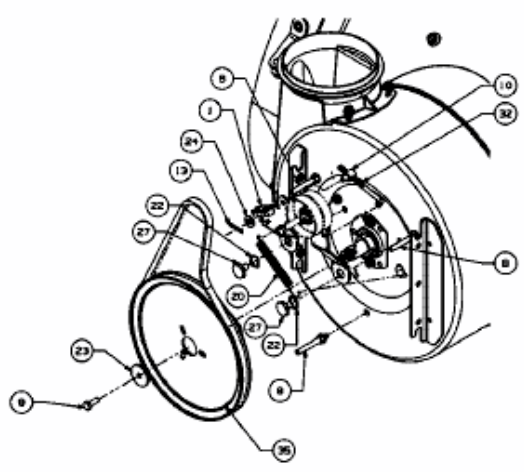

E4-01588A-01