

YM 8413 DE > 31AY9PKV643 (2009) > FRÄSFÜHRUNG

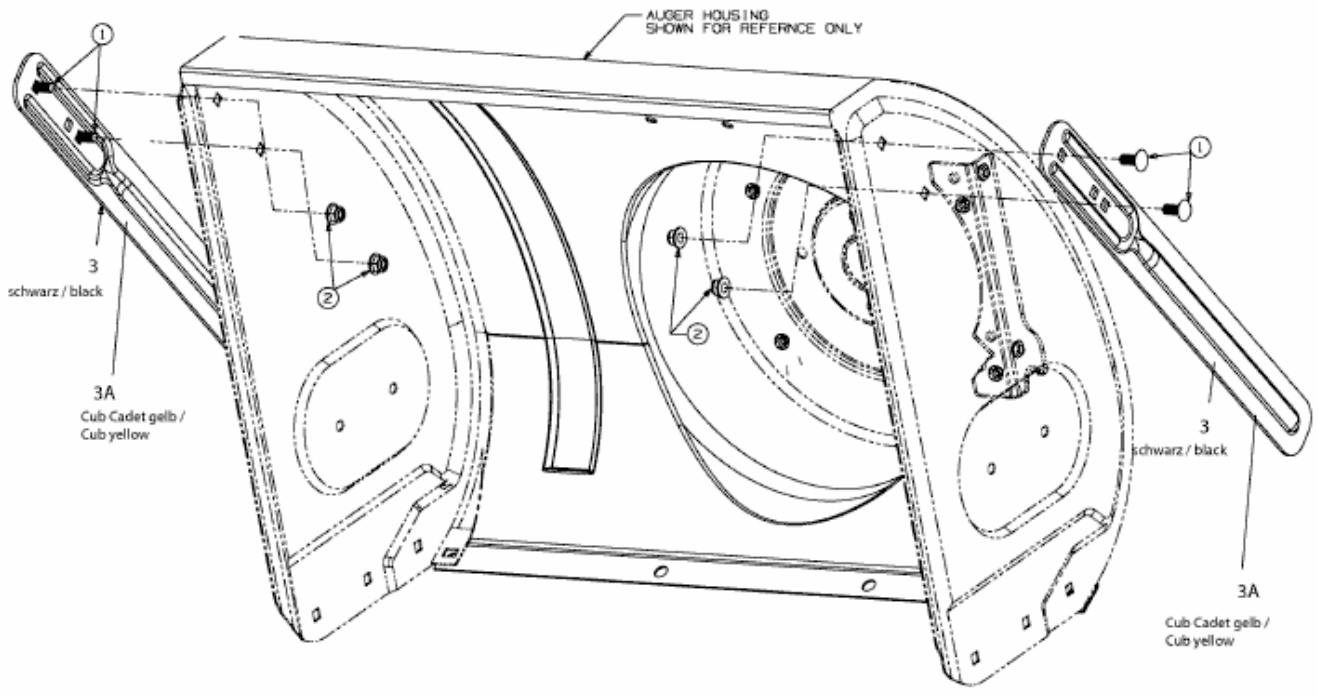

E4-02149A-01