

YM 8413 DE > 31AY9PKV643 (2008) > FRÄSGEHÄUSE

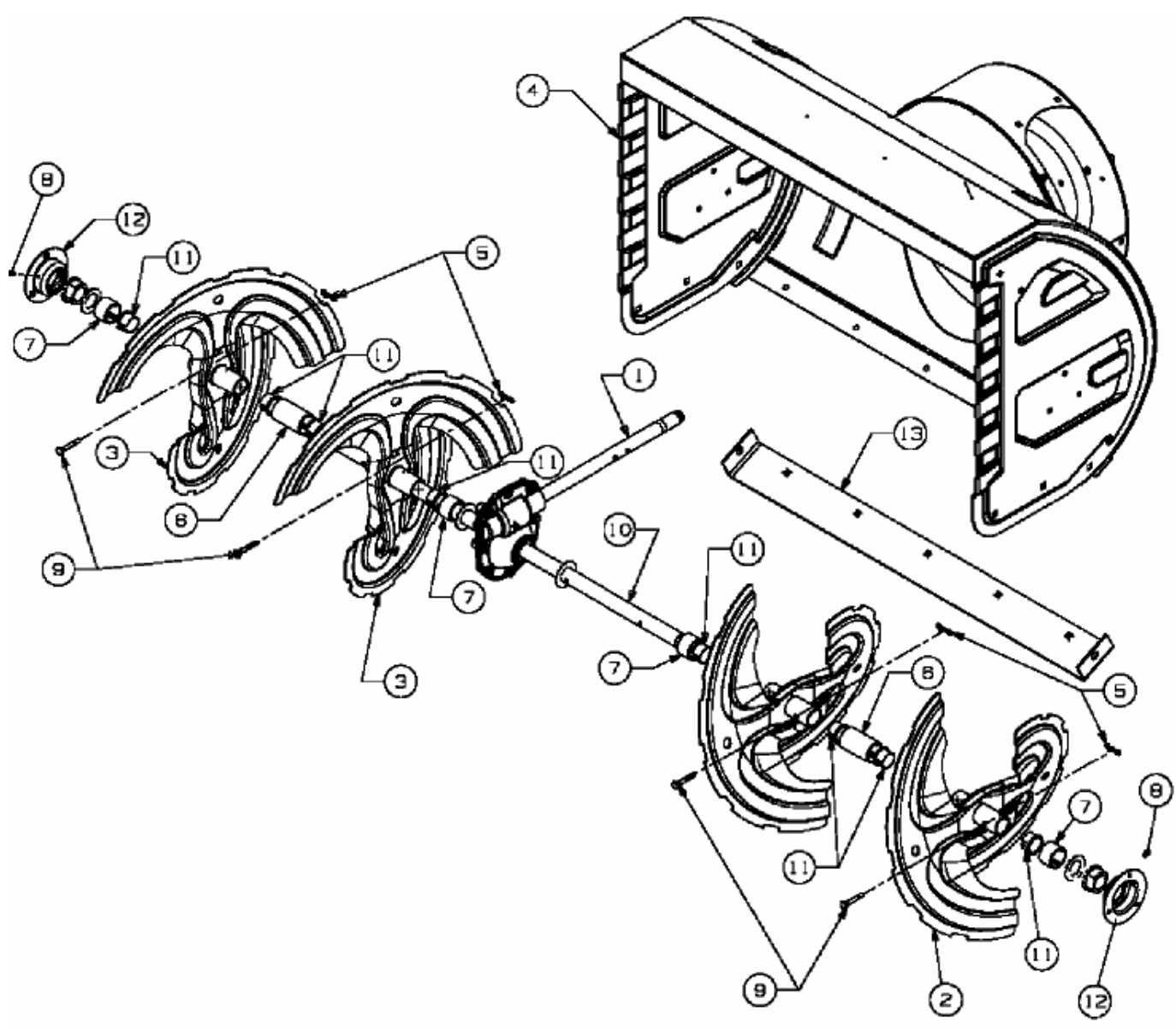

E4-02147A-01