

YM 7110 DET > 31AY7R3T643 (2009) > FRÄSGEHÄUSE

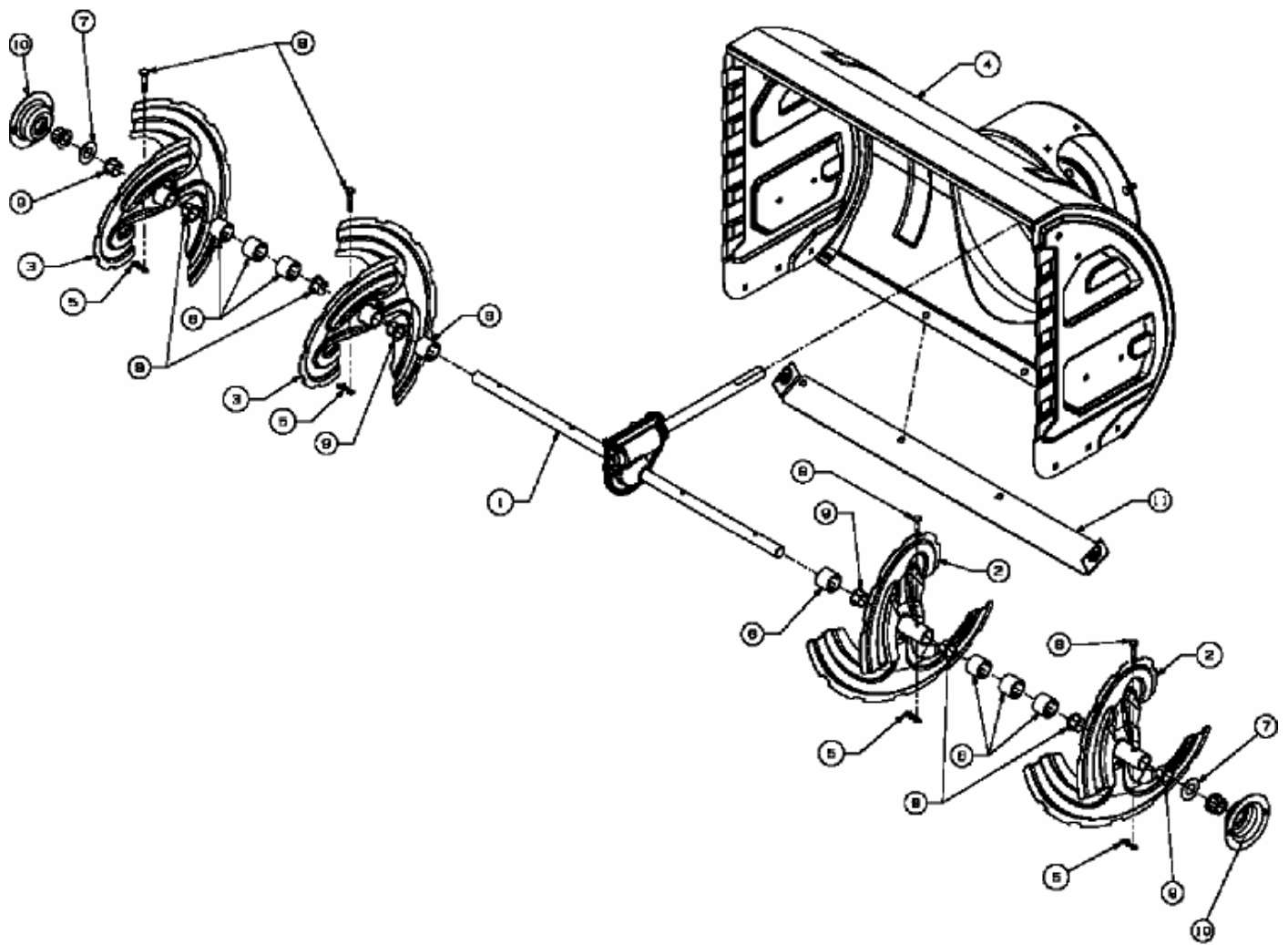

E4-02146A-01