

YM 7110 DET > 31AY7R3T643 (2008) > FAHRANTRIEB, FRÄSANTRIEB

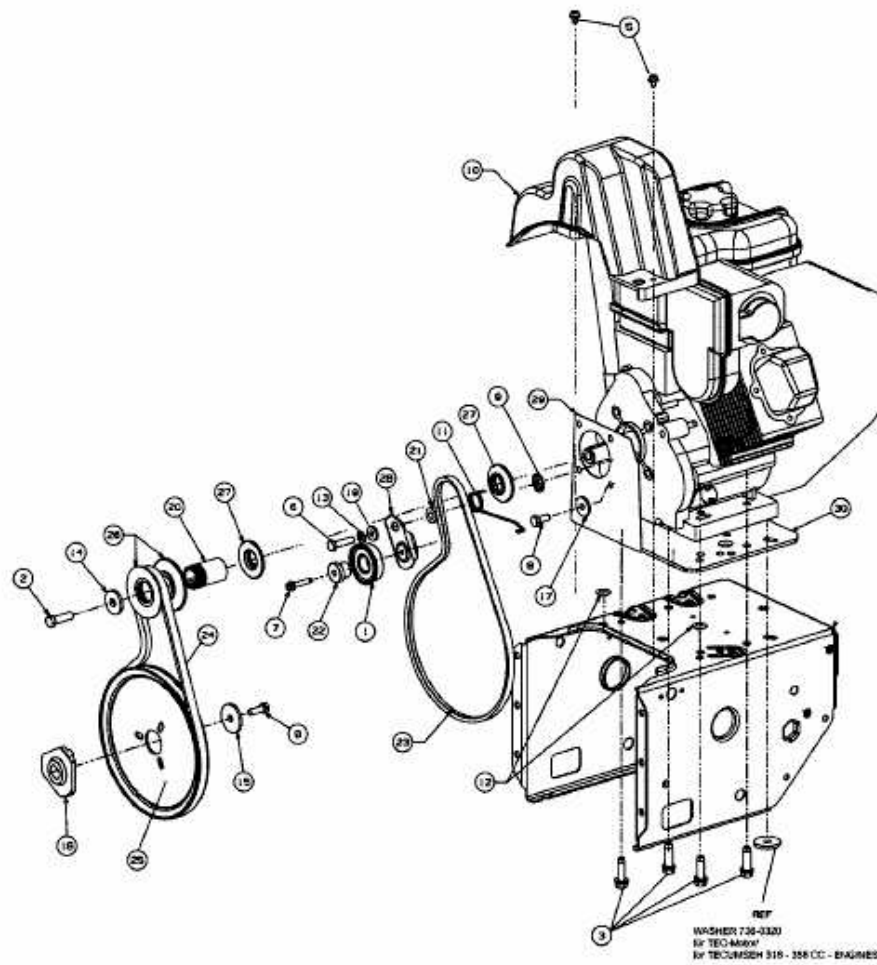

E4-02153A-01