

YM 7110 DET > 31AY7R3T643 (2008) > ABDECKUNG ARMATURENBRETT

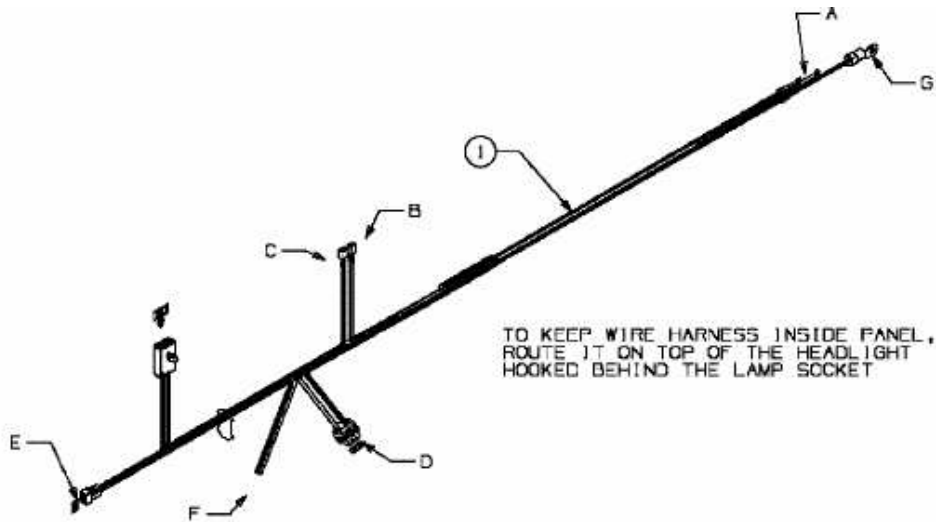

TO KEEP WIRE HARNESS INSIDE PANEL,
ROUTE IT ON TOP OF THE HEADLIGHT
HOOKED BEHIND THE LAMP SOCKET

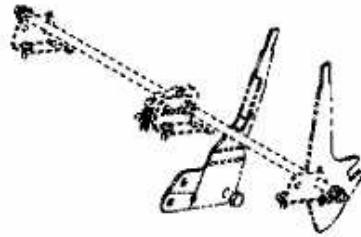
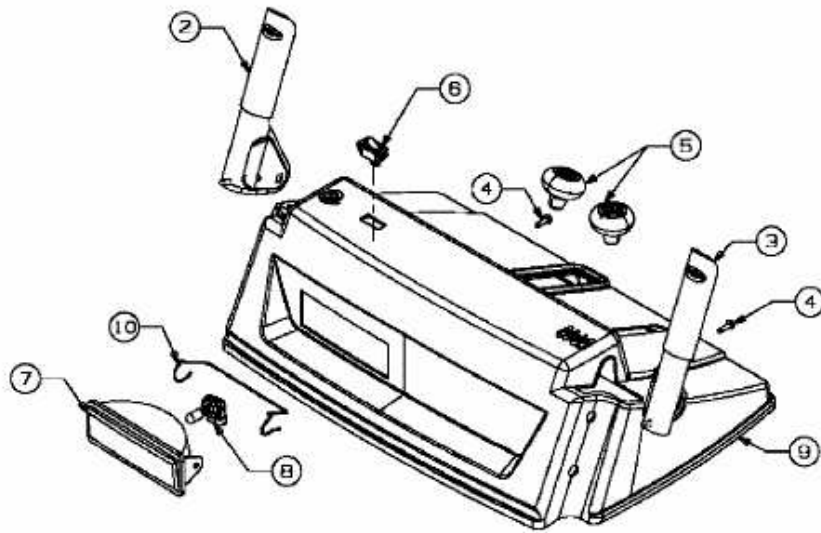

E4-01442B-01