

AMBITION SF 66 TE > 31AY74S3650 (2013) > FRÄSGEHÄUSE

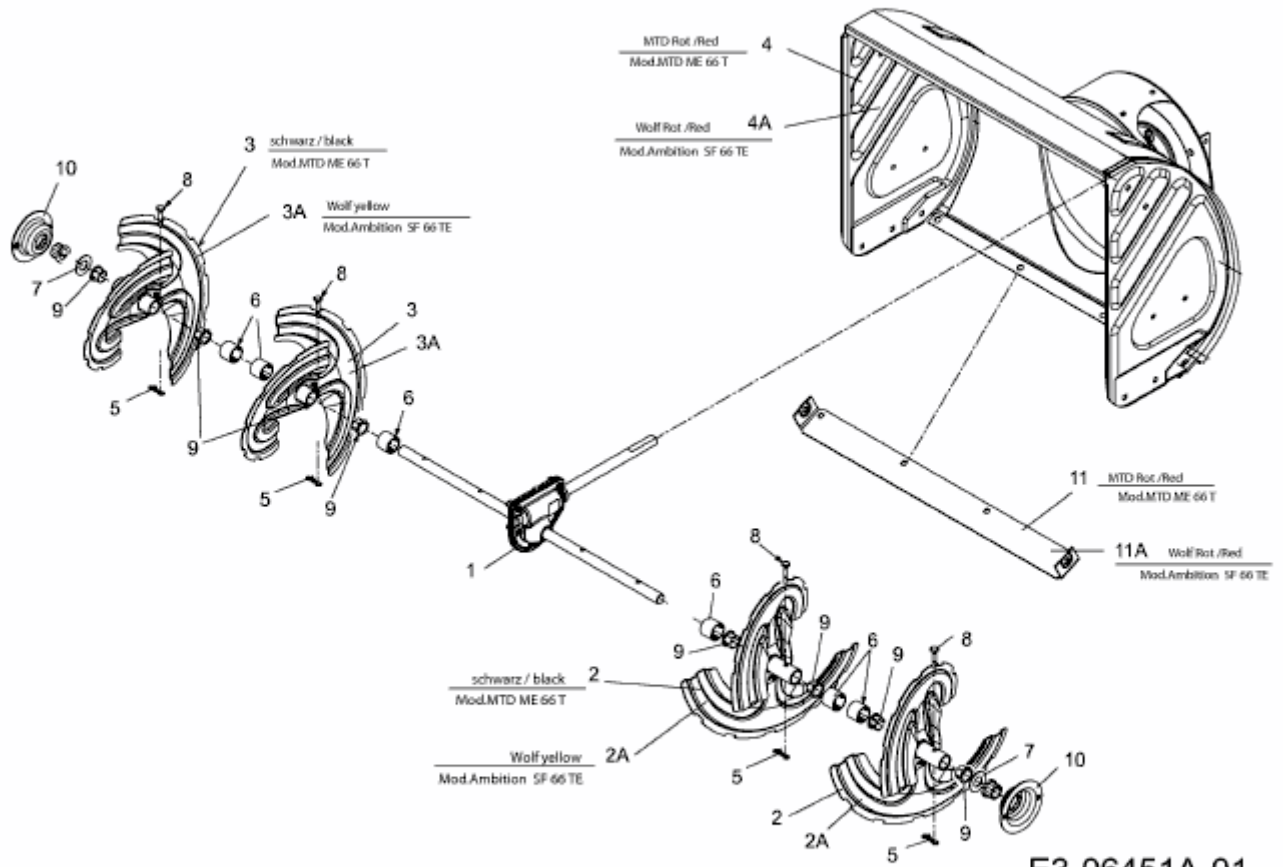

E3-06451A-01