

SNOW MAGIC DELUXE 71 > 31AY65LG615 (2013) > AUSWURFSCHACHT

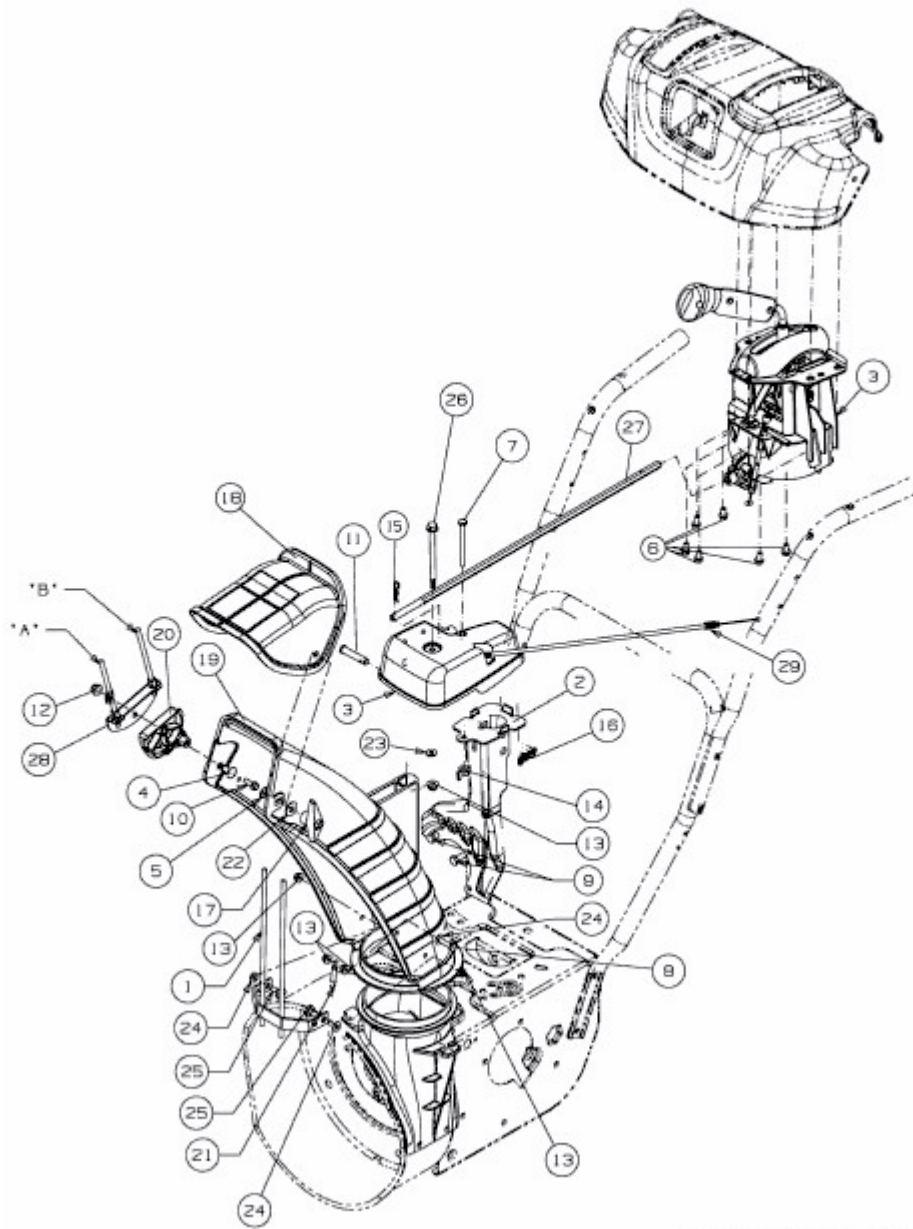

E3-06458A-01