

SNOW MAGIC DELUXE 71 > 31AY65LG615 (2013) > SCHAUFELRAD

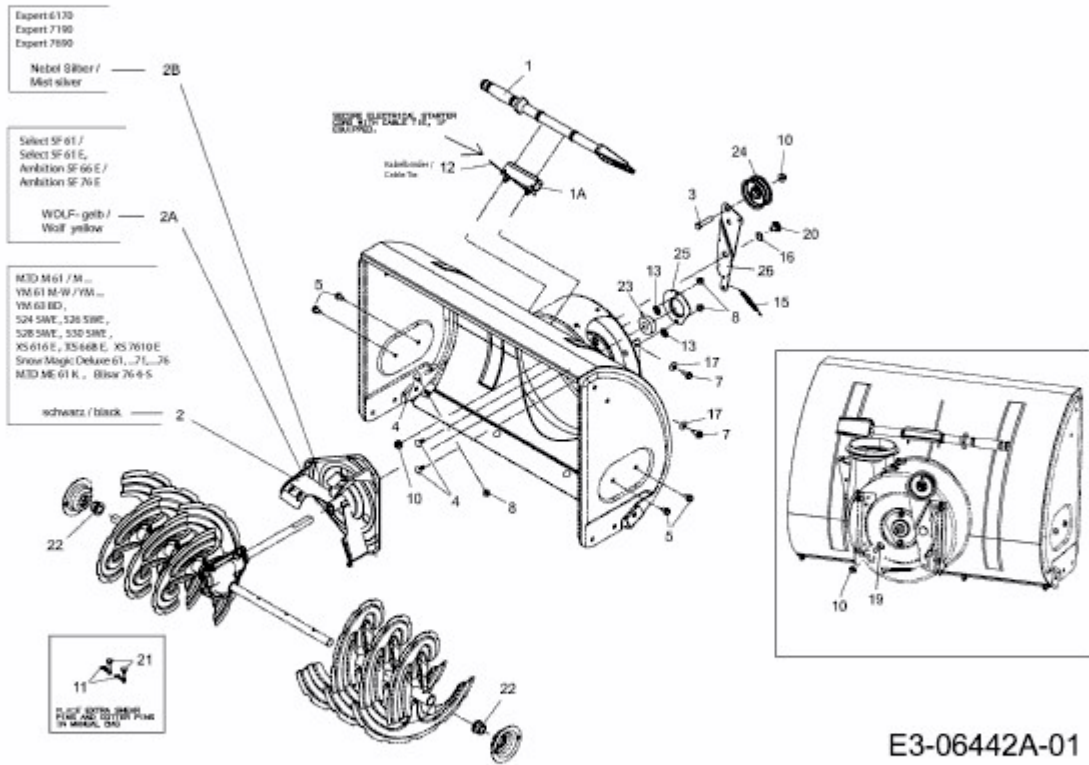

E3-06442A-01