

ME 66 > 31AY64S3678 (2013) > FRÄSGEHÄUSE

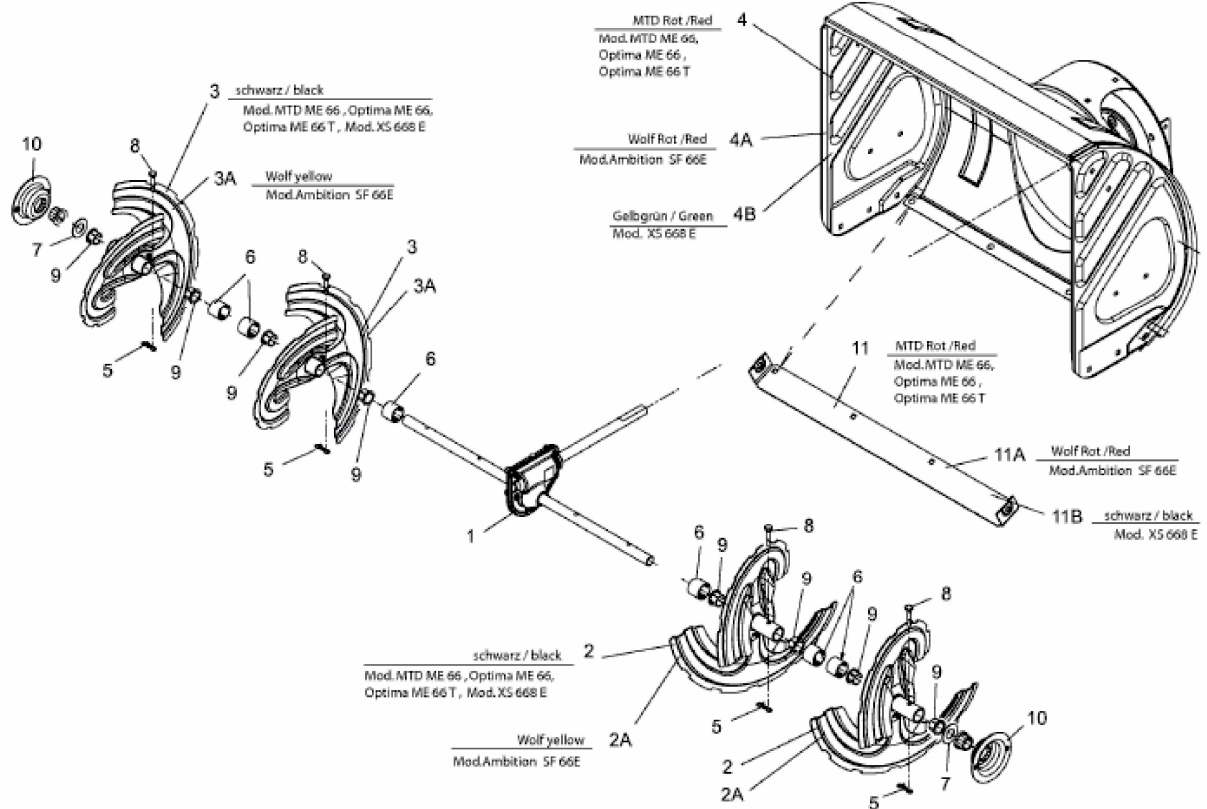

E3-06449A-01