

YM 7110 DE > 31AY5RLT643 (2009) > FAHRANTRIEB, FRÄSANTRIEB

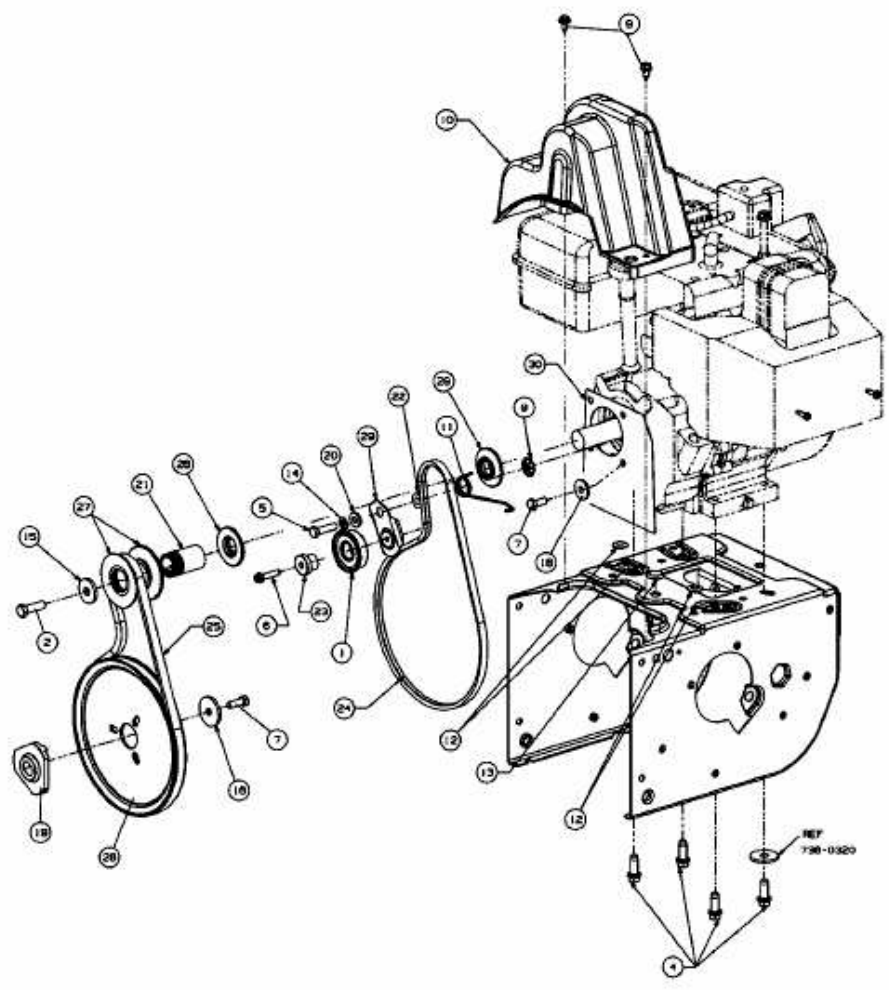

E4-01469B-01