

YM 7110 DE > 31AY5RLT643 (2008) > FRÄSFÜHRUNG

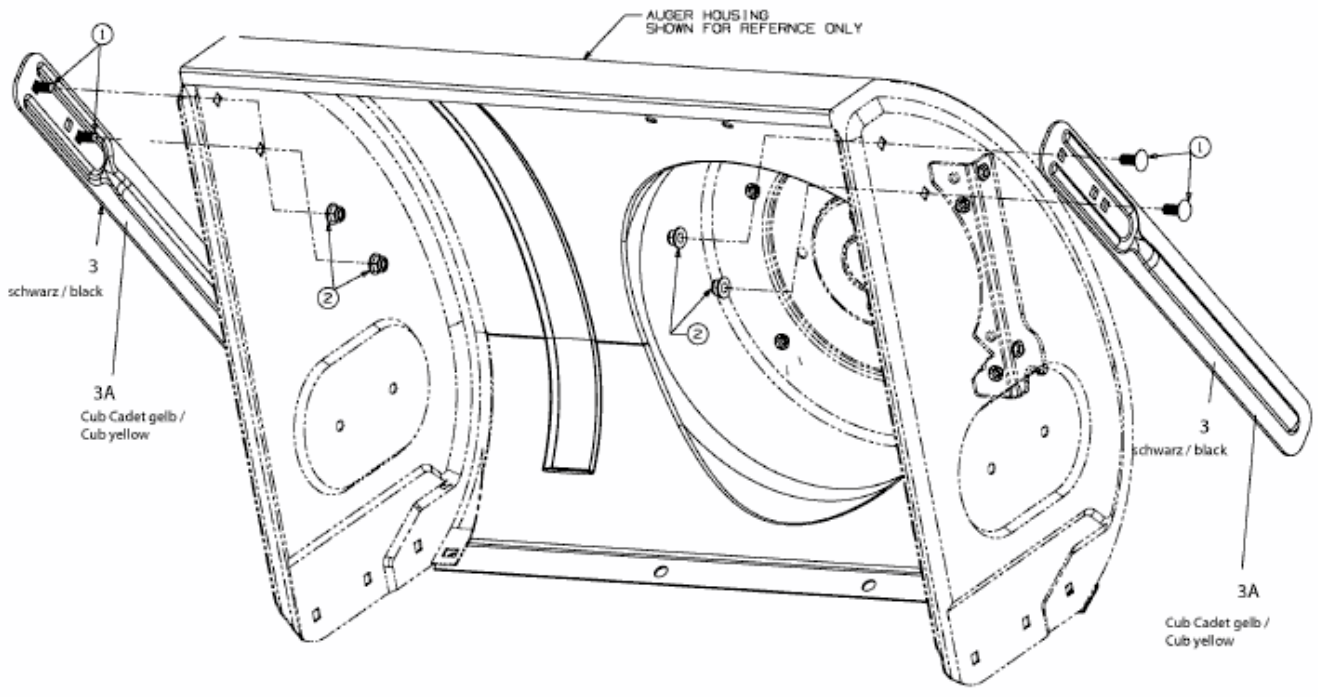

E4-02149A-01