

YM 7110 DE > 31AY5RLT643 (2008) > FRÄSGEHÄUSE

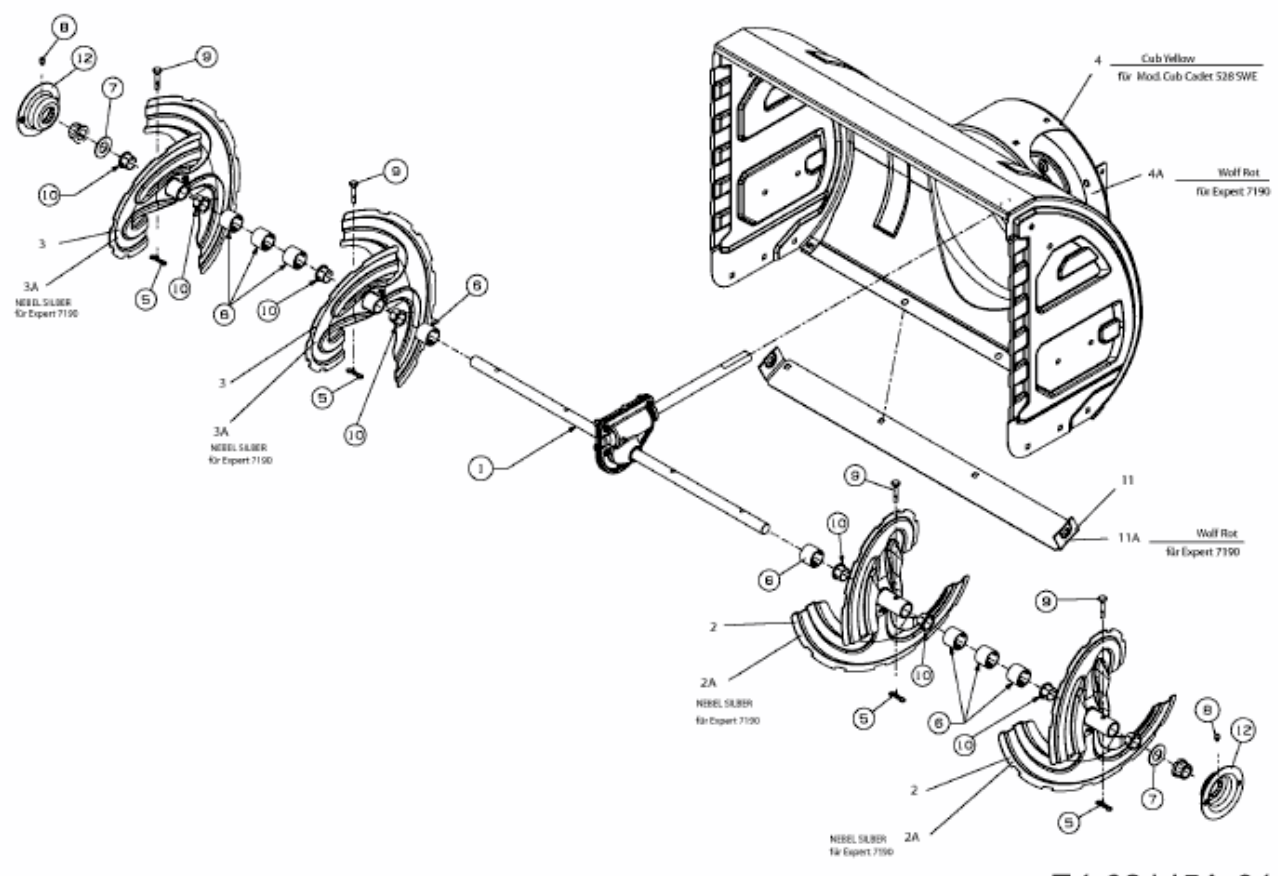

E4-02145A-01