

YM 6680 DE > 31AY56LS643 (2008) > FAHRANTRIEB, FRÄSANTRIEB

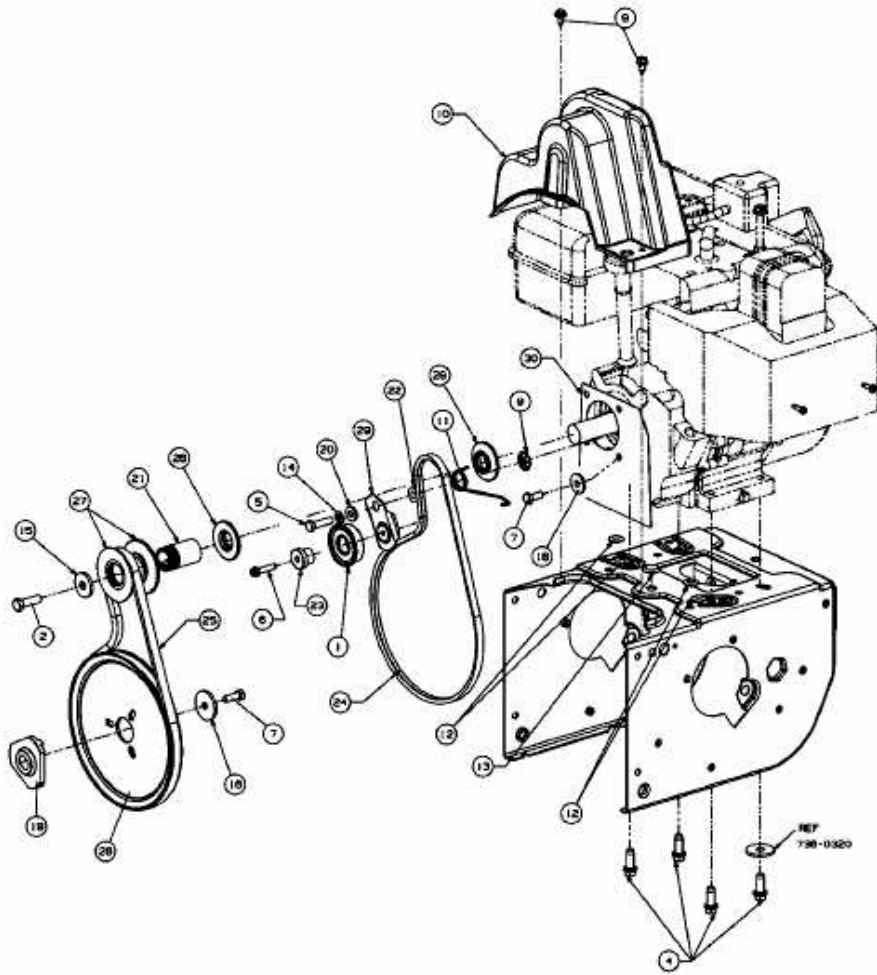

E4-01469B-01