

ab 01.10.2016
from 01.10.2016
à partir du 01.10.2016

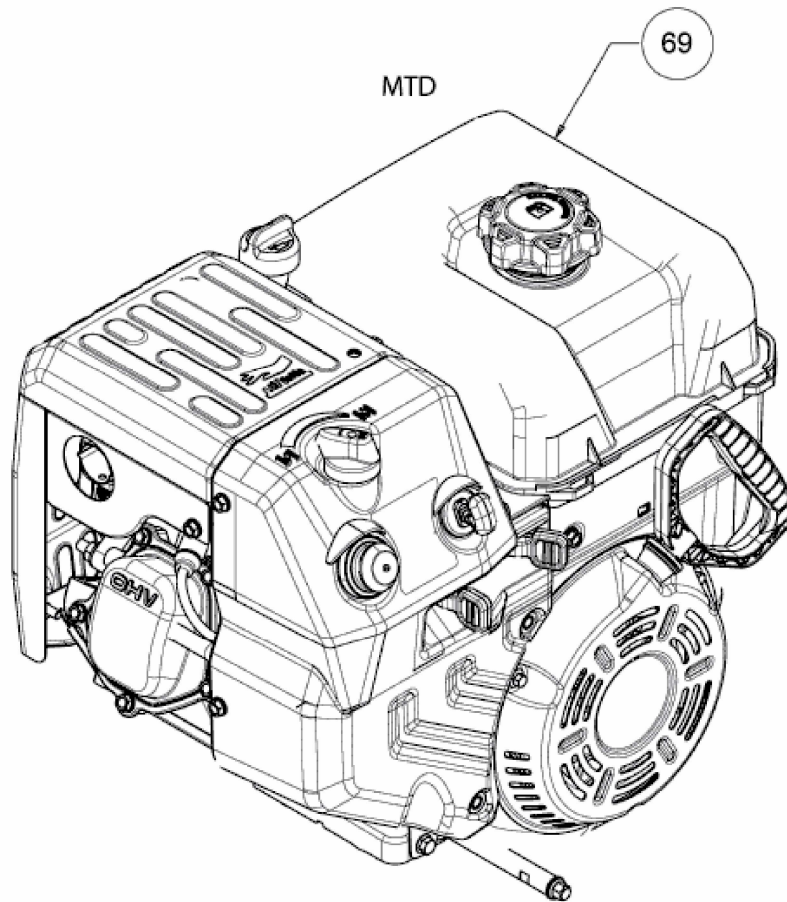

Model: 683-WH

E3-09902A-01