

ab 01.08.2014
from 01.08.2014
à partir du 01.08.2014

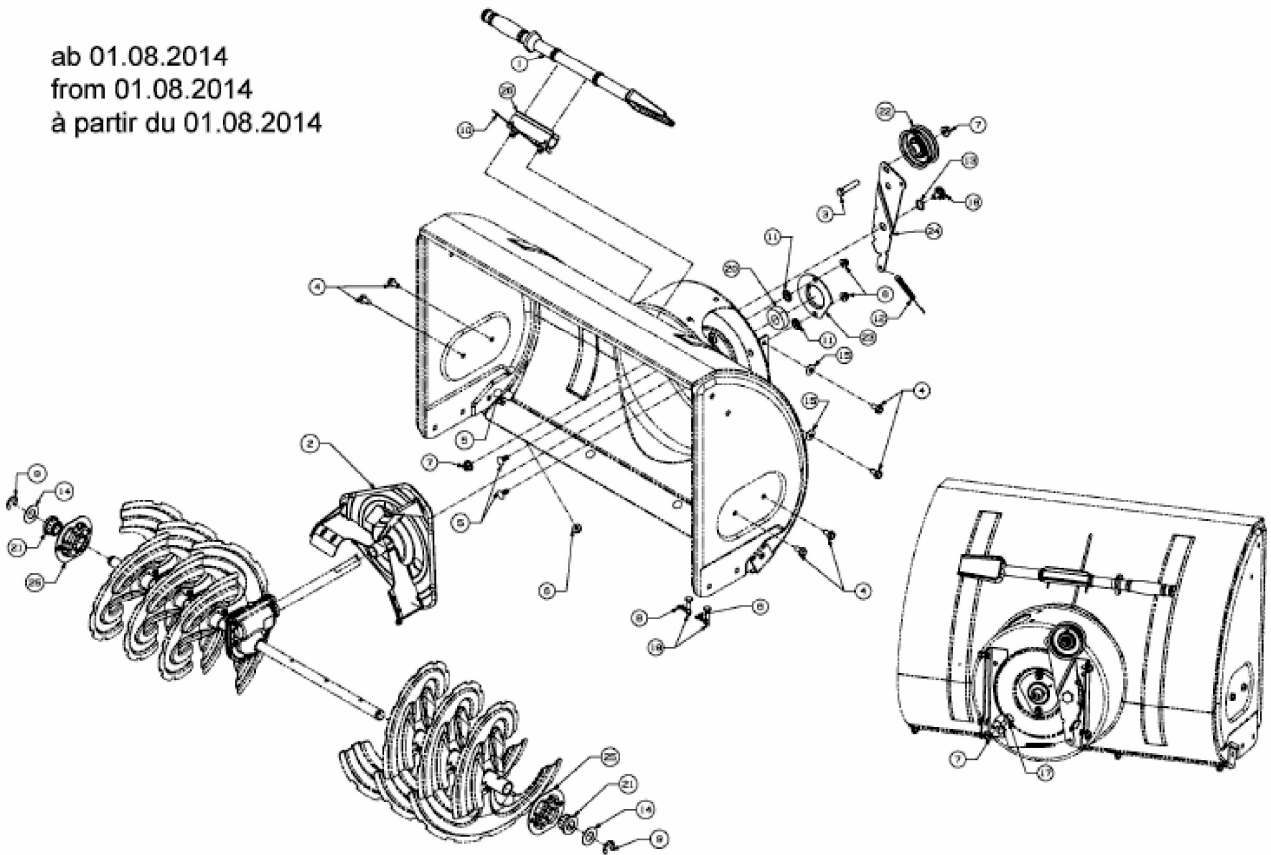

E3-08751A-02