

ab 26.06.2014
from 26.06.2014
à partir du 26.06.2014

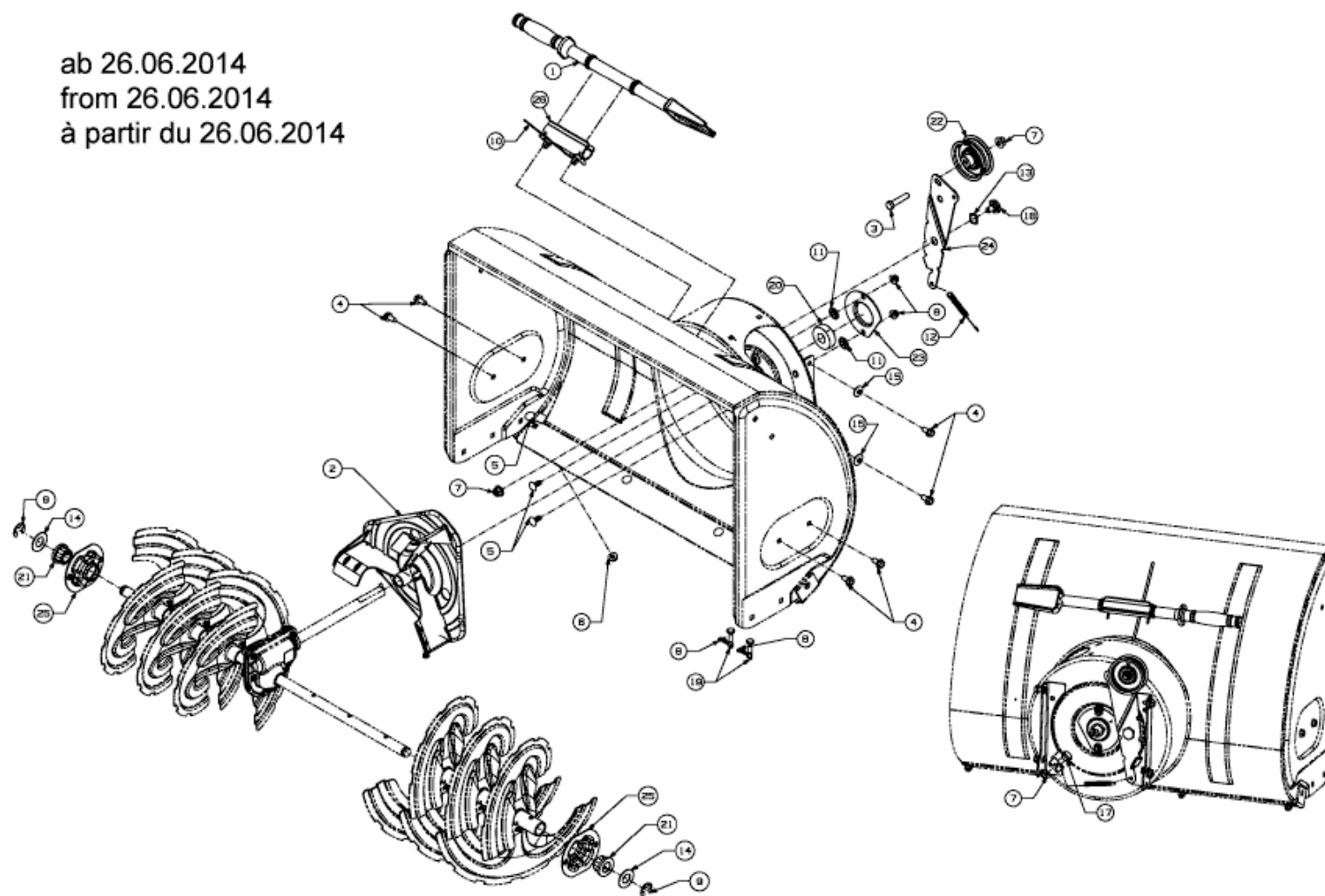

E3-08751A-05