

ab 16.10.2016  
from 16.10.2016  
à partir du 16.10.2016

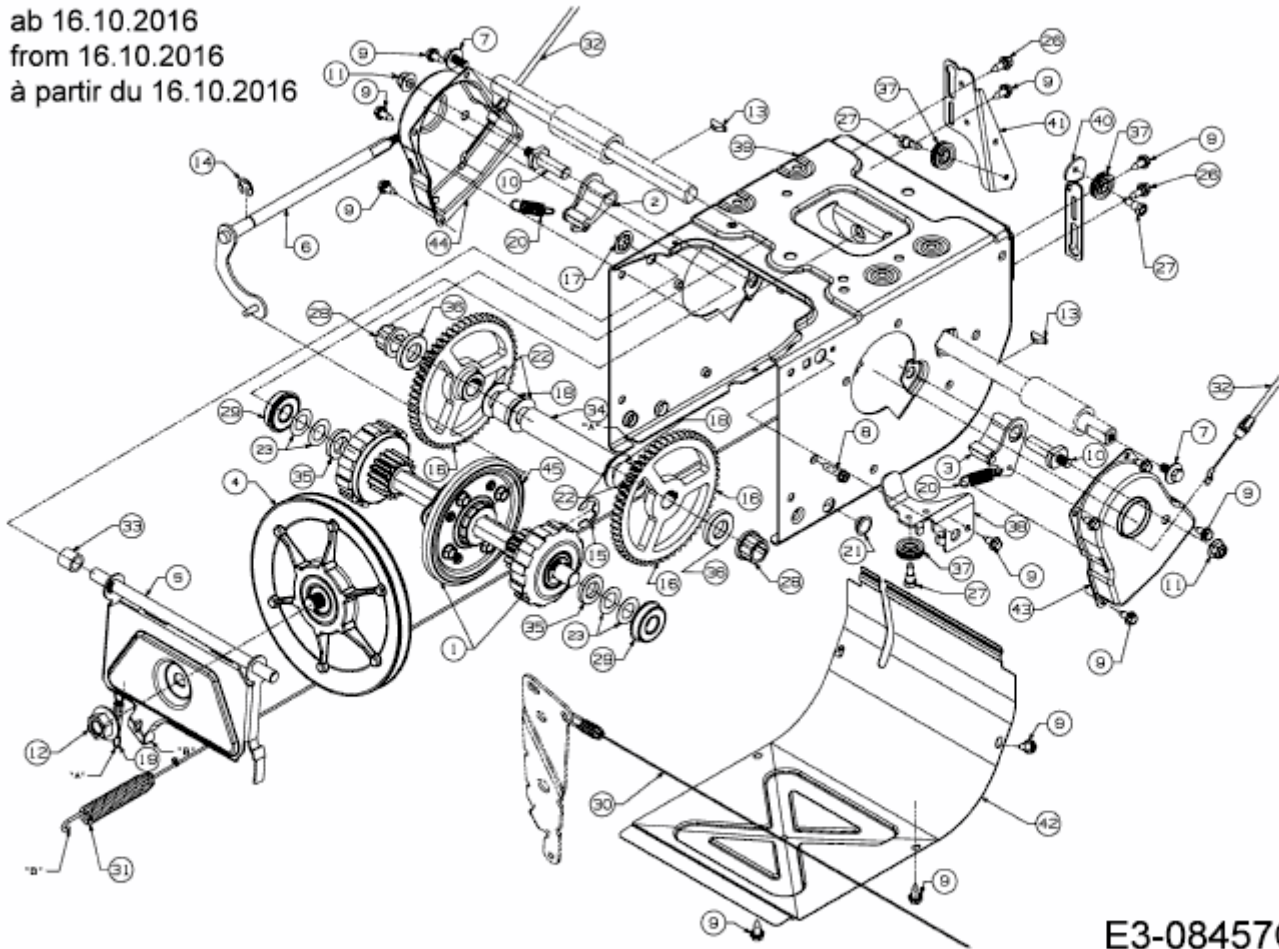

E3-08457C-02