

YM 6170 DEM > 31AY53LR643 (2009) > FRÄSGEHÄUSE

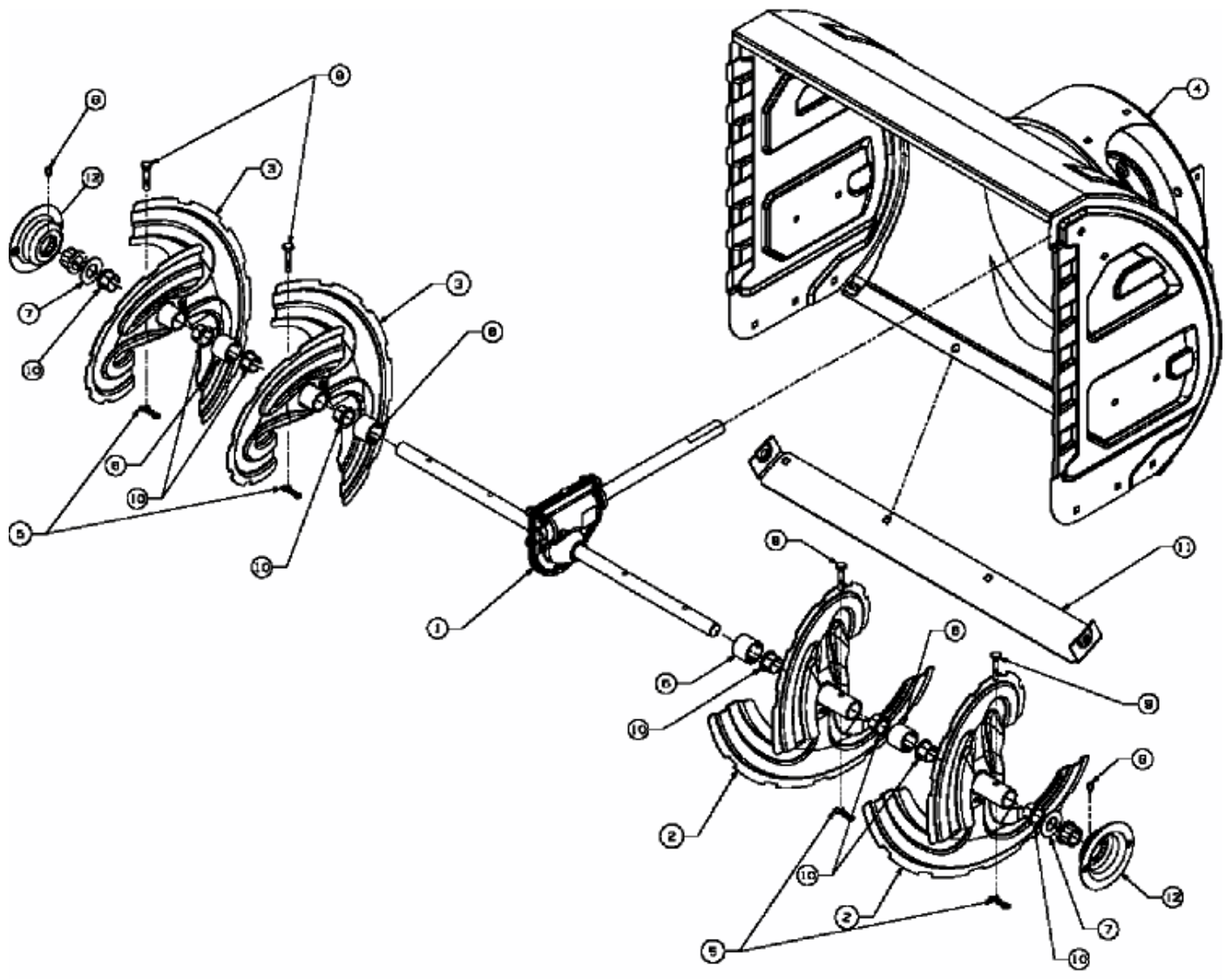

E4-02143A-01