

SNOW MAGIC DELUXE 61 > 31AW63LE615 (2014) > KABELFÜHRUNG

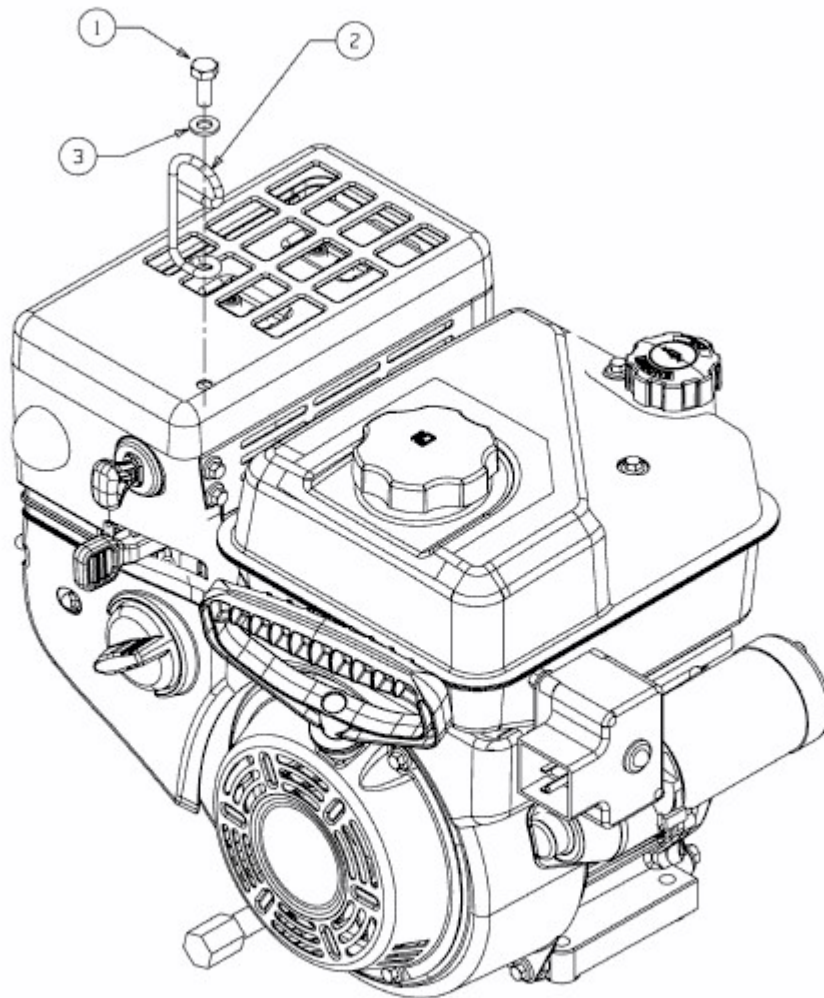

E4-02506A-01