

SNOW MAGIC DELUXE 61 > 31AW63LE615 (2014) > GLEITKUFEN

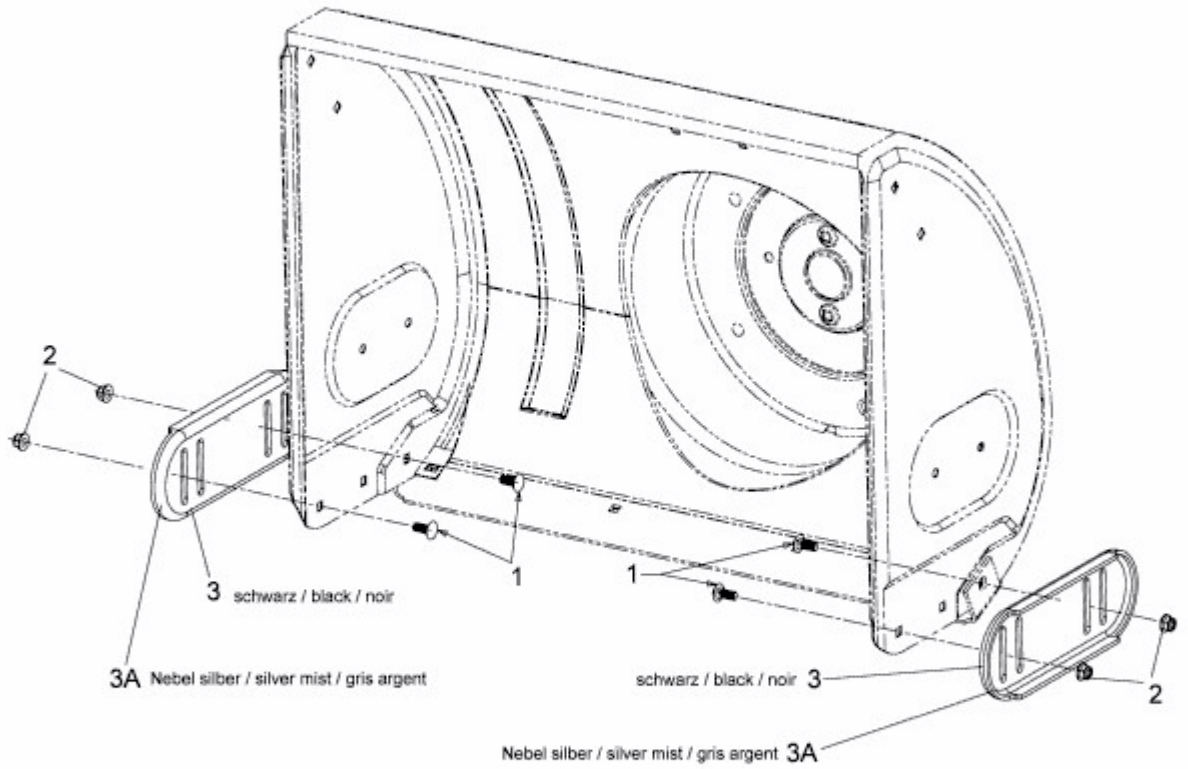

E4-01370A-01