

SNOW MAGIC DELUXE 61 > 31AW63LE615 (2012) > ARMATURENBRETT, SCHALTHEBEL

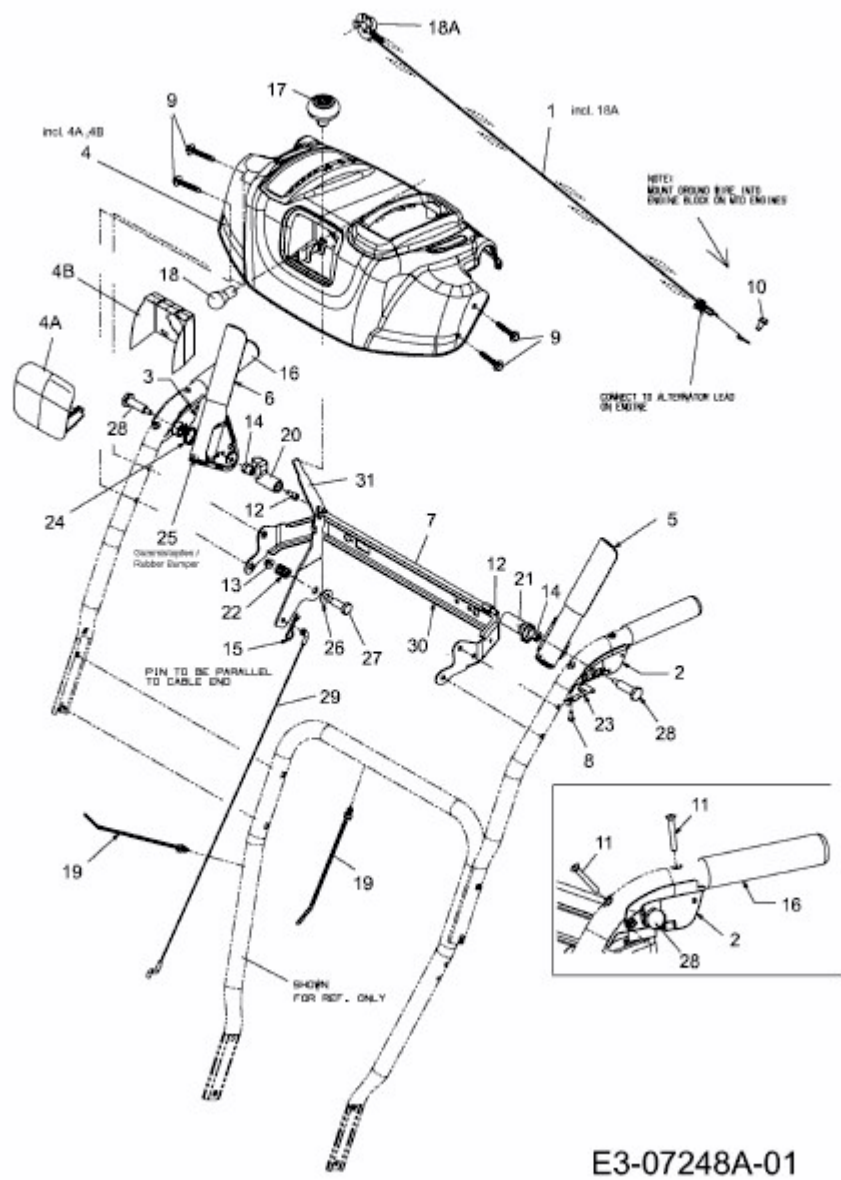

E3-07248A-01