

SNOW MAGIC DELUXE 61 > 31AW63LE615 (2012) > ADAPTER FÜR AUSWURFSCHACHT

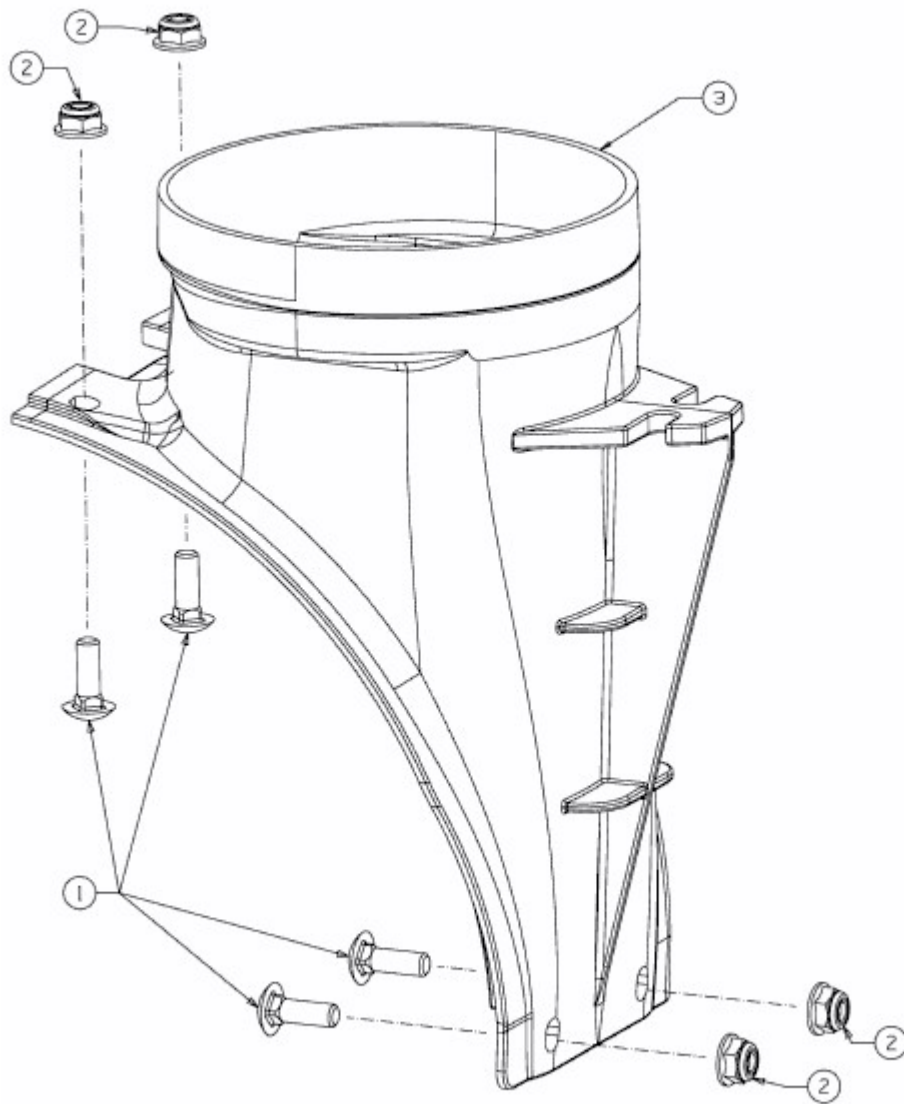

E3-06444A-01