

ab 01.08.2017
from 01.08.2017
à partir du 01.08.2017

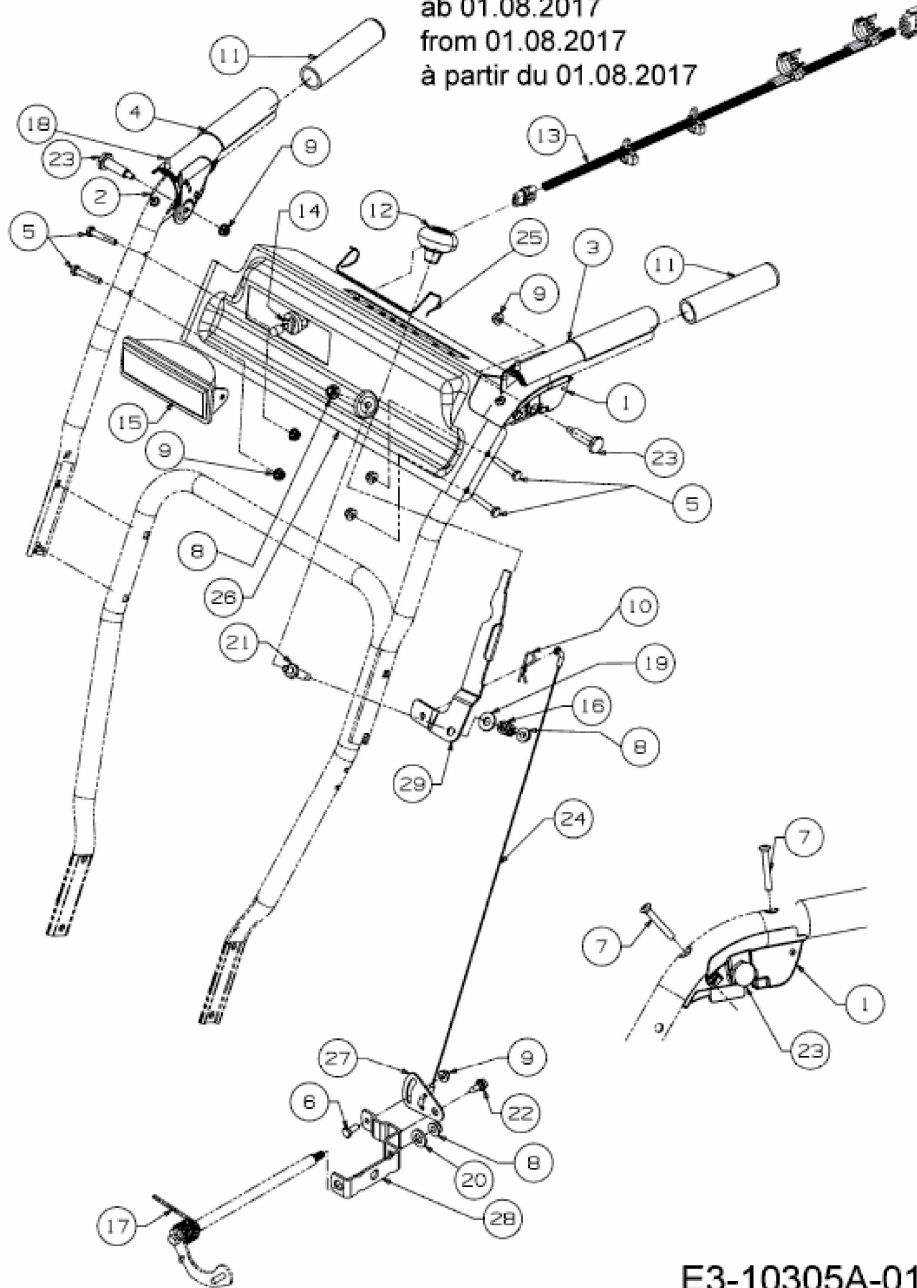

E3-10305A-01