

ab 10.08.2014
from 10.08.2014
à partir du 10.08.2014

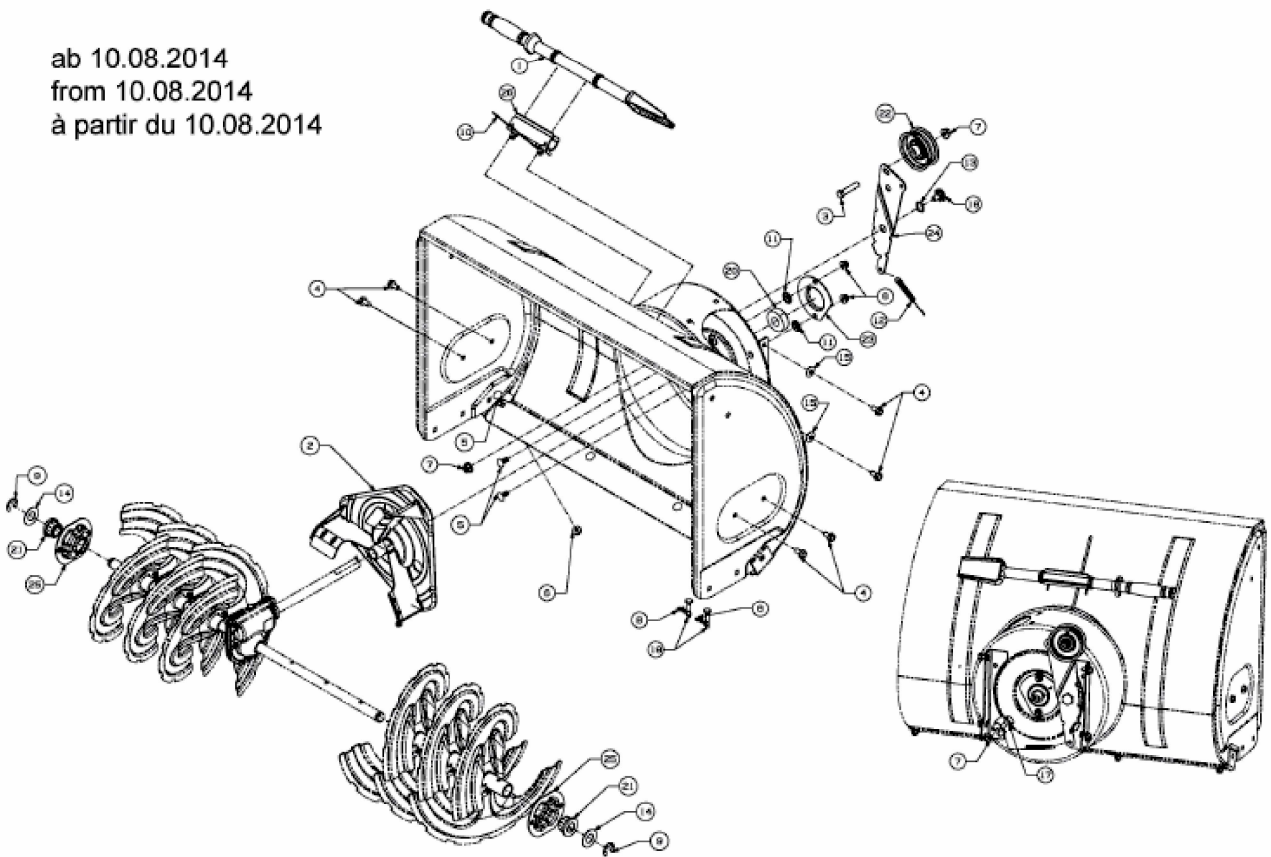

E3-08751A-03