

ab 01.10.2016  
from 01.10.2016  
à partir du 01.10.2016

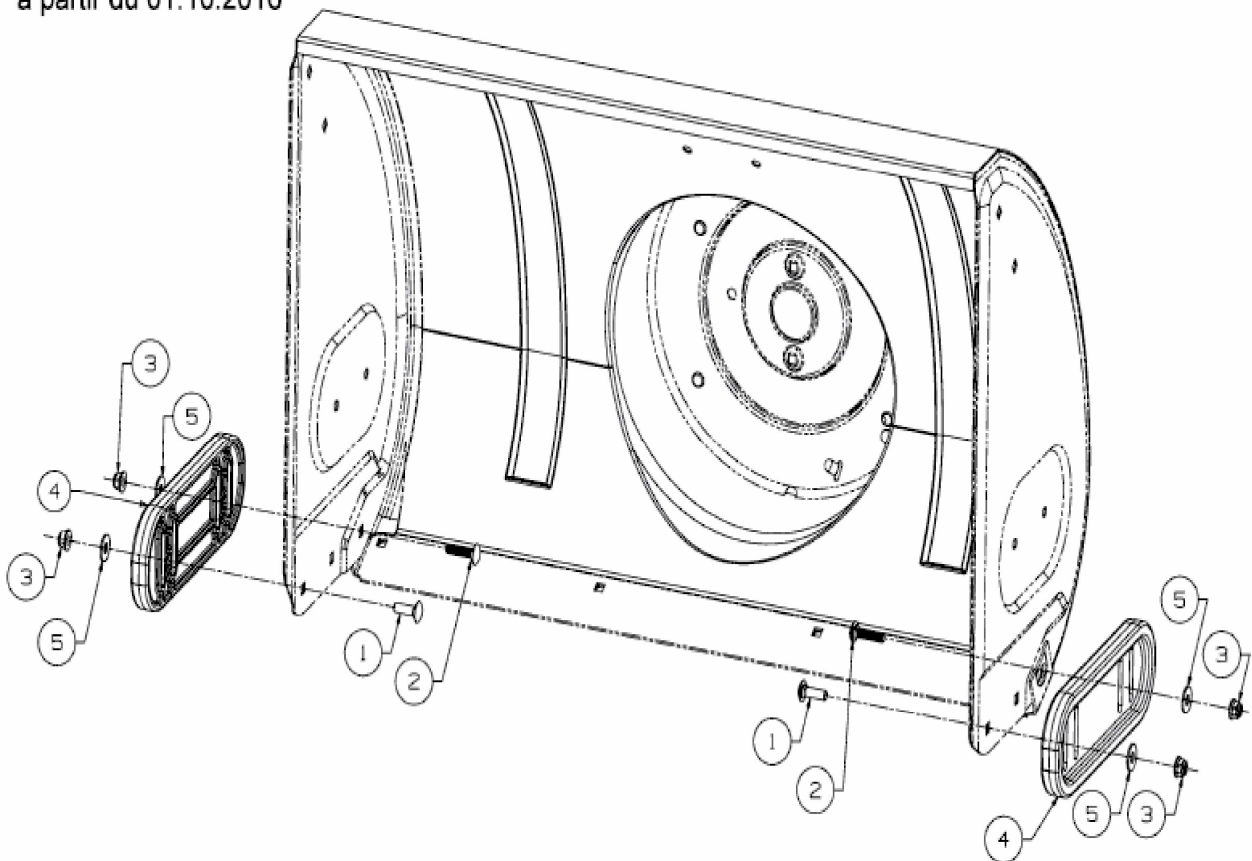

E3-07840B-02