

YM 7195 DE > 31AT7Q3G643 (2002) > EINGRIFFSCHUTZ AUSWURFSCHACHT, HOLZSTÖSSEL

SCHNEEFRÄSEN /
SNOW THROWERS

Models 140 ,150 ,611D ,641E , E640F , E660G

Models 623D ,533E ,5E3F ,7E3F , E 740F

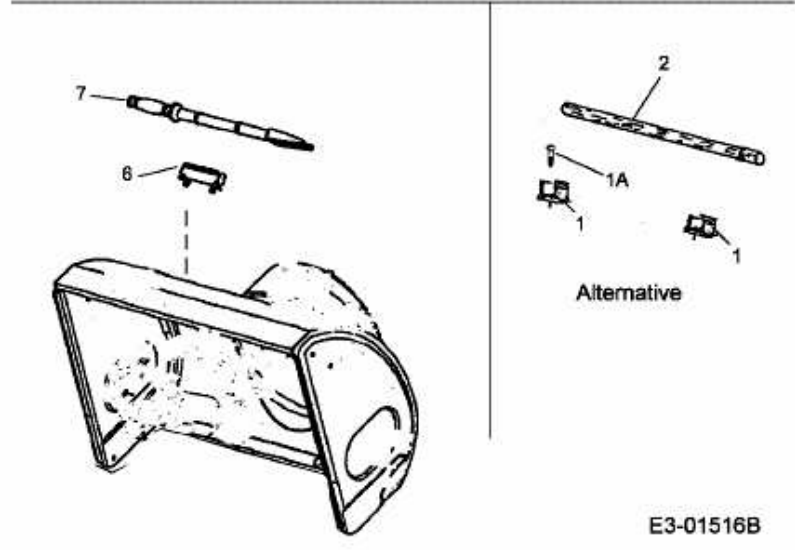
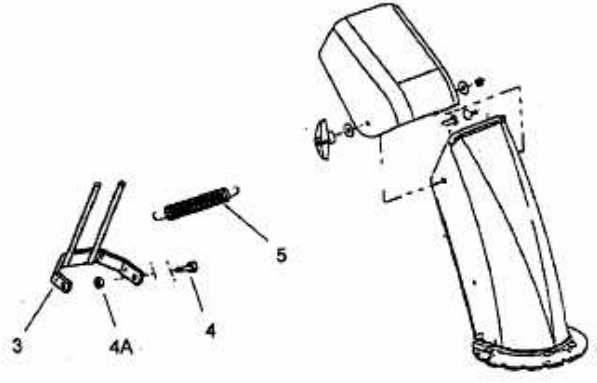

E3-01516B