

YM 7195 DE > 31AT7Q3G643 (2002) > FAHRANTRIEB

YM 7110 DET

31AY7R3G643

YM 7195 DET

31AT7Q3G643

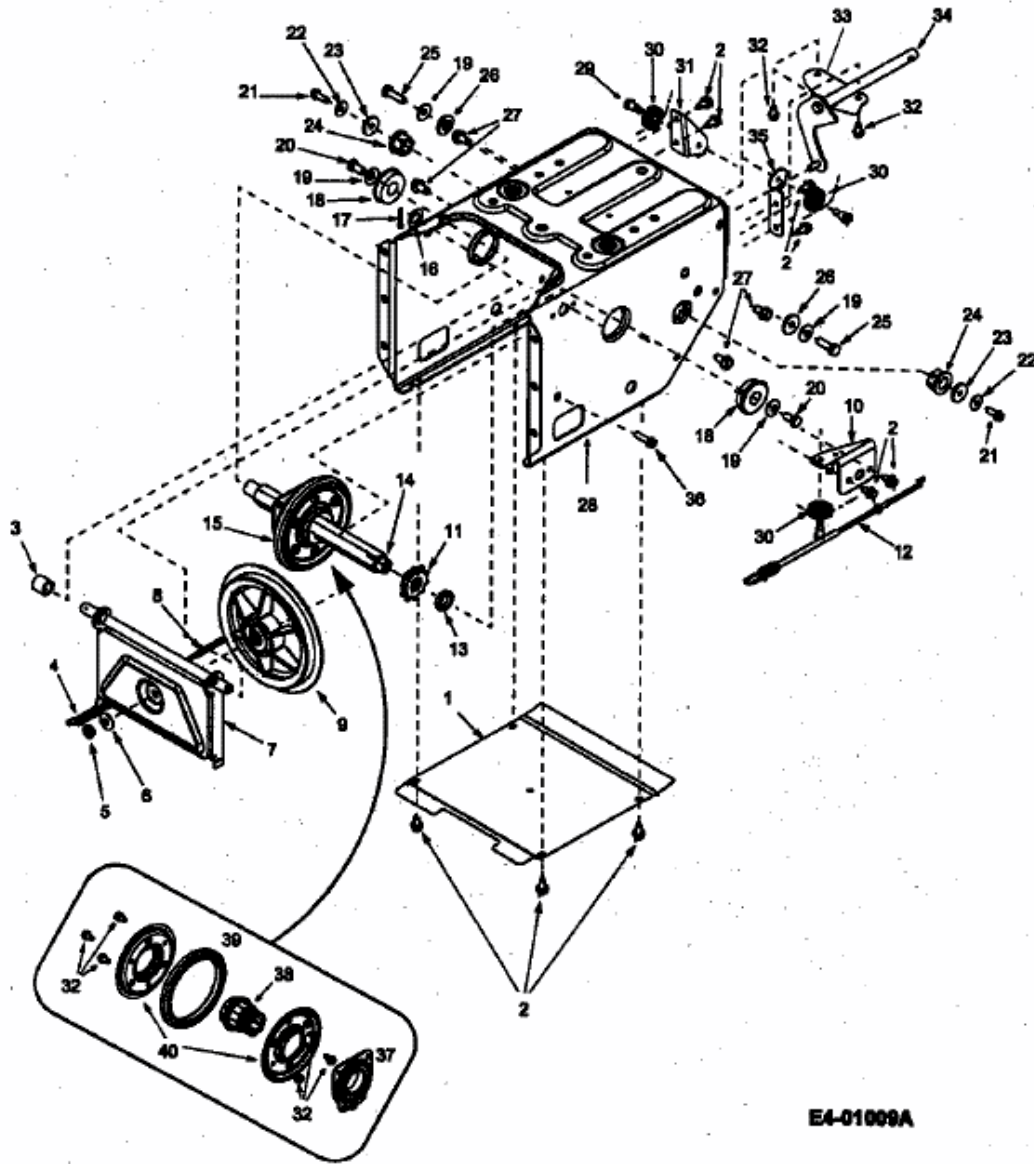

E4-01009A