

YM 5655 DE > 31AT623D643 (2005) > FAHRANTRIEB, FRÄSANTRIEB

YM 5655 DE

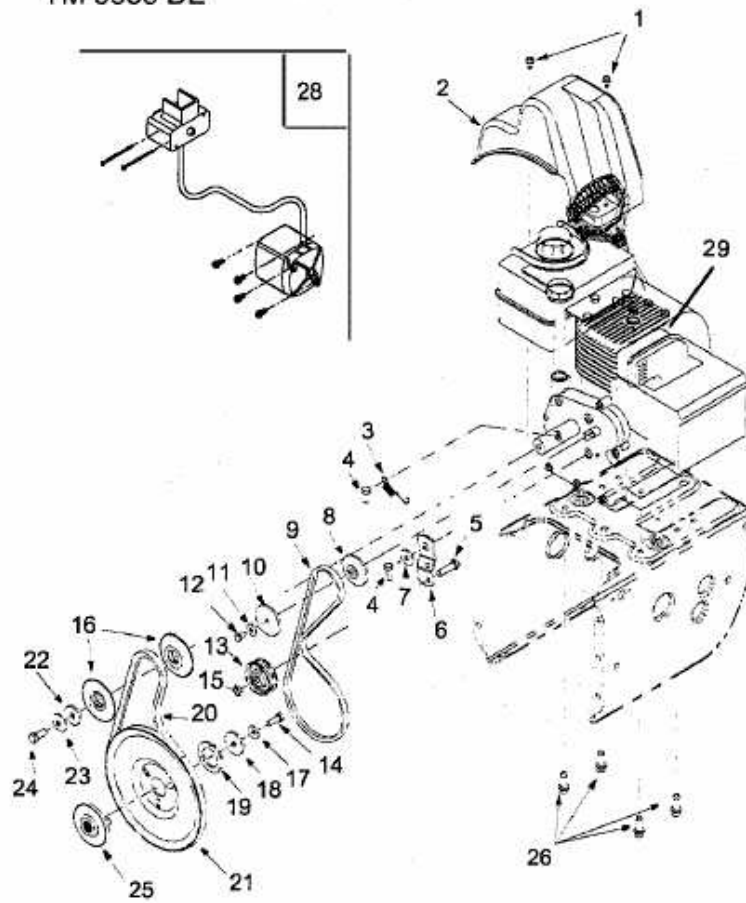

E4-01121A